 <b>OTIF</b>	<b>GENERAL PROVISIONS</b> <b>ROLLING STOCK – NOISE</b>			UTP NOI Page 1 of 48
	Status: <b>PROPOSAL</b>	Version: 01	Ref.: A 94-04/2.2011	Original: EN

## APTU Uniform Rules (Appendix F to COTIF 1999)

### **Uniform Technical Prescriptions (UTP) applicable to Rolling Stock, General provisions**

### **NOISE - (UTP NOI)**

These regulations have been developed in accordance with the provisions of APTU, in particular Article 8, in the version as amended by the OTIF Revision Committee in 2009, which entered into force on 1 December 2010.

For definitions and terms, see Article 2 of ATMF (Appendix G) and Article 2 of APTU (Appendix F), both Appendices to the 1999 version of the COTIF Convention as applicable since 1 December 2010.

Footnotes are not part of the regulations; they are only included as explanatory information.

 <b>OTIF</b>	<b>GENERAL PROVISIONS</b>		UTP NOI Page 2 of 48
	<b>ROLLING STOCK – NOISE</b>		
Status: <b>PROPOSAL</b>	Version: 01	Ref.: A 94-04/2.2011	Original: EN Date: 11.07.2011

### List of Annexes to UTP Noise (integral part of the UTP)

Ref.	Title
A	Reference track definition
B	Small deviation calculation method
C	Measurement details for stationary noise measurements
D	Measurement details for starting noise measurements
E	Measurement details for pass-by noise measurements
F	Measurement details for interior cab noise measurements
G	General information and definitions related to noise testing

 <b>OTIF</b>	<b>GENERAL PROVISIONS</b>		<b>UTP NOI</b>	
	<b>ROLLING STOCK – NOISE</b>		Page 3 of 48	
Status: <b>PROPOSAL</b>	Version: 01	Ref.: A 94-04/2.2011	Original: EN	Date: 11.07.2011

Explanatory note:

The texts of this UTP which appear across two columns are identical to corresponding texts of the European Union regulations. Texts which appear in two columns differ; the left-hand column contains the UTP regulations, the right-hand column shows the text in the corresponding EU regulations. The text in the right-hand column is for information only and is not part of the OTIF regulations.

OTIF UTP

Corresponding text in EU regulations <sup>1</sup>

EU ref. <sup>2</sup>

With reference to Article 8 of Appendix F (APTU) to the Convention, the following regulations shall apply:

## 0.1 EQUIVALENCE

Following their adoption by the Committee of Technical Experts, the OTIF regulations in this document are declared equivalent to the corresponding EU regulations within the meaning of Article 13 of APTU and Article 3a of ATMF.

## 0.2 TRANSITIONAL PROVISIONS

Wagons which have been technically admitted between 01.12.2010 and the date of entry into force of this UTP shall be subject to the same provisions as wagons which meet the provisions of ATMF Article 19.

## 1. INTRODUCTION

### 1.1 TECHNICAL SCOPE

This UTP is a technical specification covering the emission of noise by the conventional rolling stock subsystem as defined in UTP GEN-B Subsystems section 2.6. Vehicles complying with the provisions of this UTP meet the relevant essential requirements for noise and ensure the interoperability of the conventional rolling stock used, or intended to be used, in international traffic.

This TSI concerns the conventional rail rolling stock subsystem as defined in Directive 2008/57/EC, Annex II.

Further information on the rolling stock subsystem is provided in Section 2 of this document.

This UTP covers noise emitted by rolling stock in the UTP.

This TSI scope of this TSI.

It sets out noise limits generated by railway vehicles when stationary, starting noise, pass-by noise and noise inside the driver's cab.

Noise generated from braking is not in the

(Noise from braking is not in the scope of the TSI, but is not stated explicitly in the TSI)

<sup>1</sup> TSI Noise – The Annex to EU Commission Decision 2011/229/EU published in the EU Official Journal L99 on 13.04.2011.

<sup>2</sup> If no EU reference is indicated, it means that the chapter/section number is the same as in the OTIF text.

 <b>OTIF</b>	<b>GENERAL PROVISIONS</b>		<b>UTP NOI</b>	
	<b>ROLLING STOCK – NOISE</b>		Page 4 of 48	
Status: <b>PROPOSAL</b>	Version: 01	Ref.: A 94-04/2.2011	Original: EN	Date: 11.07.2011

OTIF UTP

scope of this UTP.

This UTP applies to new, upgraded or renewed railway vehicles for which technical admission is granted after this UTP has entered into force. However, it does not apply to railway vehicles which are subject to a contract of purchase, upgrade or renewal already signed before the date of entry into force of this UTP.

Corresponding text in EU regulations <sup>1</sup>

EU ref. <sup>2</sup>

(see 2.1)

## 1.2 GEOGRAPHICAL SCOPE

2.1

### 1.2.1 The geographical scope of this

UTP is the OTIF conventional rail system made up of those lines in the Contracting States which carry international traffic. When the term "OTIF conventional rail system" is used in this document, it refers to this scope. International traffic is defined in ATMF Article 2 I).

TSI is the trans-European conventional rail system network (TEN) as described in Annex I to Directive 2008/57/EC.

## 1.3 CONTENT OF THIS DOCUMENT

### 1.3.1 This UTP

In accordance with Article 5(3) of the Directive 2008/57/EC, this TSI

(a) indicates its intended scope

(part of the network or rolling stock referred to in Annex I to the Directive; subsystem or part of subsystem referred to in Annex II to the Directive)

– Section 1 and 2;

(b) lays down essential requirements for the rolling stock concerned and for its interfaces with other subsystems

– Section 3;

(c) establishes the functional and technical specifications to be met by the subsystem and its interfaces with other subsystems

– Section 4;

(d) states, in each case under consideration, which procedures are to be used in order to assess the subsystem's conformity with this UTP

– Section 6;

for the "EC" verification of the subsystems

(e) sets out the strategy for implementing this UTP

– Section 7;

TSI

(f) indicates, for the staff concerned, the professional qualifications and health and safety conditions at work required for the operation and maintenance of the subsystem, as well as for the implementation of this UTP

– Section 4.

TSI

This

UTP

| TSI

does not contain specifications related to elements of construction (interoperability | interoperability constituents.

 <b>OTIF</b>	<b>GENERAL PROVISIONS</b>		<b>UTP NOI</b>	
	<b>ROLLING STOCK – NOISE</b>		Page 5 of 48	
Status: <b>PROPOSAL</b>	Version: 01	Ref.: A 94-04/2.2011	Original: EN	Date: 11.07.2011

OTIF UTP

constituents).

In accordance with

Article 8 § 6 of Appendix F (APTU) to the Convention,

provisions may be made for specific cases for each UTP;

these provisions are set out in Section 7.

Corresponding text in EU regulations <sup>1</sup>

EU ref. <sup>2</sup>

Article 5(5) of the Directive,

for each TSI;

## 1.4 STANDARDS

Upon adoption of this UTP, the standards referenced in it (except those in the right-hand column) are deemed to be validated in accordance with Article 5 of APTU.

## 2. DEFINITIONS AND INTER-FACES

## DEFINITION OF SUBSYSTEM/SCOPE

### 2.1 DEFINITIONS

### DEFINITION OF THE SUBSYSTEM

(See section 1.2)

The rolling stock that is the subject of this TSI comprises the units defined in this clause which are likely to travel on all or part of the trans-European conventional rail network. The present TSI includes limits for stationary noise, starting noise, pass-by noise and driver's cab interior noise.

#### 2.1.1 Self propelling thermal or electric trains

This type of unit includes any passenger train, consisting of one or more vehicles, in fixed or pre-defined formation. Thermal or electric traction equipment is installed in some (or all) vehicles of the train (except for railcars), and the train is fitted with at least one driver's cab.

This type is further referred to as multiple units.

Examples of multiple units: trainset, electric and/or diesel multiple unit, railcar.

#### 2.1.2 Thermal or electric traction units

This type of unit includes traction vehicles that are not capable of carrying a payload, such as thermal or electric locomotives or power heads. These vehicles are intended for freight or/and passenger transport.

This type is further referred to as locomotives.

Examples of locomotives: locomotive, shunter, power head, power car.

#### 2.1.3 Passenger carriages

This type of unit includes non-traction vehicles carrying passengers and/or luggage and operated in a variable formation with vehicles from the category "thermal or electric traction units" defined above to provide the traction function.

This type is further referred to as coaches.

 <b>OTIF</b>	<b>GENERAL PROVISIONS</b>		<b>UTP NOI</b>	
	<b>ROLLING STOCK – NOISE</b>		Page 6 of 48	
Status: <b>PROPOSAL</b>	Version: 01	Ref.: A 94-04/2.2011	Original: EN	Date: 11.07.2011

OTIF UTP

| Corresponding text in EU regulations <sup>1</sup>

EU ref. <sup>2</sup>

Examples of coaches: coach, driving coach, van, driving trailer and car carriers when intended to be used in passenger trains.

#### 2.1.4 **Freight wagons, including vehicles designed to carry lorries**

This type of unit includes non-traction vehicles intended to carry freight and not intended to accommodate human beings during operation.

This type is further referred to as freight wagons, or wagons.

#### 2.1.5 **Mobile railway infrastructure construction and maintenance equipment**

This type of unit is in the scope of the UTP

| TSI

only when

- it is running on its own rail wheels, and
- it is designed to have characteristics necessary for the operation of track based train detection systems and
- it is in transport (running) configuration on its own rail wheels, self-propelled or hauled.

Working configuration is outside the scope of this UTP.

| TSI.

This type of unit is further referred to as OTMs. OTM units, shall meet the requirements as set out for locomotives in this UTP.

| TSI.

### 2.2 **INTERFACES**

### **INTERFACES OF SUBSYSTEM**

This noise UTP

| TSI

has interfaces with:

- The freight wagon category, with regard to:
  - pass-by noise,
  - stationary noise;
- The locomotives, multiple units, OTMs and coaches categories, with regard to:
  - stationary noise,
  - starting noise (not applicable to coaches),
  - pass-by noise,
  - interior noise within the driver's cab, where applicable.

## 3. **ESSENTIAL REQUIREMENTS**

### 3.1 **GENERAL**

In the scope of the present UTP

| TSI

compliance with the relevant essential requirements set out in section 3 of this UTP

| TSI

will be ensured by compliance with the specifications described in chapter 4 for the subsystem, as demonstrated by a positive result of the assessment of conformity with the UTP, | the verification of the subsystem, as described in section 6.

Nevertheless, if part of the essential requirements is covered by national rules be-

 <b>OTIF</b>	<b>GENERAL PROVISIONS</b>		<b>UTP NOI</b>	
	<b>ROLLING STOCK – NOISE</b>		Page 7 of 48	
Status: <b>PROPOSAL</b>	Version: 01	Ref.: A 94-04/2.2011	Original: EN	Date: 11.07.2011

OTIF UTP | Corresponding text in EU regulations <sup>1</sup> EU ref. <sup>2</sup>

cause of:

- open and reserved points declared in the UTP, | TSI,
- a derogation according to ATMF, | under article 9 of Directive 2008/57/EC,
- or specific cases described in section 7.6 of the present UTP, | TSI,

the corresponding conformity assessment shall be carried out according to procedures under the responsibility of the Contracting State | Member State concerned.

### 3.2 THE ESSENTIAL REQUIREMENTS RELATE TO:

- Safety
- Reliability and availability
- Health
- Environmental protection
- Technical compatibility.

These requirements include general requirements, and requirements specific to each subsystem.

### 3.3 GENERAL ESSENTIAL REQUIREMENTS <sup>3</sup>

*Essential Requirements 1.4.4 of UTP GEN-A*

*| Annex III to Directive 2008/57/EC.*

#### 3.3.1 Environmental protection

*| Operation of the trans-European conventional rail system must respect existing regulations on noise pollution.*

As far as the rolling stock subsystem regarding noise emitted by rolling stock is concerned, this essential requirement is addressed by the specification of the subsections:

- Pass-by noise (basic parameters 4.2.1.1 and 4.2.2.4),
- Stationary noise (basic parameters 4.2.1.2 and 4.2.2.2),
- Starting noise (basic parameter 4.2.2.3),
- Interior noise of locomotives, multiple units and driving trailers (basic parameter 4.2.3).

## 4. SPECIFICATION OF MAXIMUM NOISE LEVELS

## CHARACTERISATION OF THE SUBSYSTEM

### 4.1 INTRODUCTION

The OTIF conventional rail system,

*| The trans-European conventional rail system, to which Directive 2008/57/EC applies and*

of which the rolling stock subsystem is a part, is an integrated system whose consis-

<sup>3</sup> UTP GEN-A does not include any essential requirements relating to the health of staff, neither as a general requirement (1.3), nor as one specific to the subsystem rolling stock (2.4). A reference to regulations on the health of staff is included in section 4.2.3.

 <b>OTIF</b>	<b>GENERAL PROVISIONS</b>		<b>UTP NOI</b>	
	<b>ROLLING STOCK – NOISE</b>		Page 8 of 48	
Status: <b>PROPOSAL</b>	Version: 01	Ref.: A 94-04/2.2011	Original: EN	Date: 11.07.2011

OTIF UTP

| Corresponding text in EU regulations <sup>1</sup> EU ref. <sup>2</sup>

tency shall be verified. This consistency shall be checked in particular with regard to the specifications of the subsystem, its interfaces vis-à-vis the system in which it is integrated, as well as the operating and maintenance rules.

Taking account of all the applicable essential requirements, the rolling stock subsystem regarding noise emitted by rolling stock is characterised in this chapter.

This

UTP

| TSI

shall be applicable to new vehicles, and renewed or upgraded rolling stock if required by the provisions of chapter 7.

Annex G provides general information and definitions relating to noise testing. When not described in this

UTP

| TSI

the relevant EN standards shall be used with regards to terms, definitions, instrumentation and calibration, quality of the measurements, test report requirements and other general information related to noise testing.

## 4.2

### FUNCTIONAL AND TECHNICAL SPECIFICATIONS

### FUNCTIONAL AND TECHNICAL SPECIFICATIONS OF THE SUBSYSTEM

The Annexes to this UTP are to be considered as an integral part of it.

In light of the essential requirements in chapter 3, the functional and technical specifications of the rolling stock subsystem regarding noise emitted by rolling stock are as follows:

- stationary noise (basic parameters 4.2.1.2 and 4.2.2.2),
- starting noise (basic parameter 4.2.2.3),
- pass-by noise (basic parameters 4.2.1.1 and 4.2.2.4),
- interior noise of locomotives, multiple units and driving trailers (basic parameter 4.2.3).

### 4.2.1

#### NOISE EMITTED BY FREIGHT WAGONS

Noise emitted by freight wagons subdivides into pass-by noise and stationary noise.

The pass-by noise of a freight wagon is highly influenced by its rolling noise (noise of the wheel/rail contact) which is a function of speed.

The rolling noise itself is caused by the combined wheel and rail acoustic roughness and by the dynamic behaviour of the track and wheel-set.

The parameter set for the characterisation of pass-by noise comprises:

- sound pressure level, according to a defined measuring method.
- microphone position,
- speed of the wagon,
- track conditions (e.g. rail acoustic roughness, vertical and lateral track decay rates.)

Stationary noise of a freight wagon will only be of relevance if the wagon is equipped with auxiliary devices like engines, generators, cooling systems.

The parameters set for the characterisation of stationary noise comprise:

- sound pressure level, according to a defined measuring method and microphone position,
- operating conditions.

 <b>OTIF</b>	<b>GENERAL PROVISIONS</b>		<b>UTP NOI</b>	
	<b>ROLLING STOCK – NOISE</b>		Page 9 of 48	
Status: <b>PROPOSAL</b>	Version: 01	Ref.: A 94-04/2.2011	Original: EN	Date: 11.07.2011

OTIF UTP

|Corresponding text in EU regulations<sup>1</sup>

EU ref.<sup>2</sup>

#### 4.2.1.1 Limits for pass-by noise

The indicator for pass-by noise is the A-weighted equivalent continuous sound pressure level  $L_{pAeq,Tp}$  measured over the pass-by time at a distance of 7.5 m from the centre of the track, 1.2 m above top of rail.

Measurements shall be made in accordance with annex E.

The measured pass-by noise levels shall comply with the values as set out in Table 1 when measured on track complying with annex A. It is permitted to carry out the test on track that does not comply with annex A and if the noise levels do not exceed the values shown in Table 1, there is a presumption of conformity to this requirement.

The following conditions of the track on which the pass-by noise measurement is performed shall be measured and recorded:

- the vertical and lateral track decay rate in accordance with EN15461;
- the track acoustic roughness in accordance with EN15610.

If the track on which the measurements were performed did meet the reference conditions as set out in annex A, or if the acceptance criterion of annex B is met, the measured values shall be marked “comparable”. Otherwise the measured values shall be marked “non-comparable”.

An entry shall be recorded in the technical file and in the OTIF Register of admitted types

|ERATV

if the measured values are “comparable” or “non-comparable”. Measured values of noise, as well as corresponding track quality shall be saved in the technical file for later evaluation of correspondence between vehicle and track noise for both comparable and non-comparable data.

The measured acoustic rail roughness remains valid during a period starting three months before the measurement and ending three months after the measurement, provided that during this period no track maintenance has been performed which influences the rail acoustic roughness.

The measured track decay rates remain valid during a period starting one year before the measurement and ending one year after the measurement, provided that during this period no track maintenance has been performed which influences the track decay rates.

If beyond the limits of these periods, the same stretch of track is used again for pass-by noise measurements, it is necessary to measure the acoustic roughness or decay rates again. Proof shall be provided in the technical file that the track data related to the type's pass-by noise measurement were valid during the day(s) of testing, e.g. by providing the date of last maintenance having an impact on noise.

 <b>OTIF</b>	<b>GENERAL PROVISIONS</b>			UTP NOI Page 10 of 48
	<b>ROLLING STOCK – NOISE</b>			
Status: <b>PROPOSAL</b>	Version: 01	Ref.: A 94-04/2.2011	Original: EN	Date: 11.07.2011

OTIF UTP

Corresponding text in EU regulations<sup>1</sup>  
Table 1

EU ref.<sup>2</sup>

Wagons	$L_{pAeq,Tp}$ in dB
New wagons with an average number of axles per unit length (apl) up to $0.15 \text{ m}^{-1}$ at 80 km/h	82
Renewed or upgraded wagons according to ATMF Article 10 § 11 <sup>4</sup> with an average number of axles per unit length (apl) up to $0.15 \text{ m}^{-1}$ at 80 km/h	84
New wagons with an average number of axles per unit length (apl) higher than $0.15 \text{ m}^{-1}$ to $0.275 \text{ m}^{-1}$ at 80 km/h	83
Renewed or upgraded wagons according to ATMF Article 10 § 11 <sup>4</sup> with an average number of axles per unit length (apl) higher than $0.15 \text{ m}^{-1}$ up to $0.275 \text{ m}^{-1}$ at 80 km/h	85
New wagons with an average number of axles per unit length (apl) higher than $0.275 \text{ m}^{-1}$ at 80 km/h	85
Renewed or upgraded wagons according to ATMF Article 10 § 11 <sup>4</sup> with an average number of axles per unit length (apl) higher than $0.275 \text{ m}^{-1}$ at 80 km/h	87

Apl is the number of axles divided by the length over buffers.

If the maximum operational speed of the unit is lower than 80 km/h, the unit shall be tested at this maximum speed, the pass-by noise limits for 80 km/h apply without any correction. Otherwise the pass by noise of a unit shall be measured at 80 km/h and at V (where V = 190 km/h or the maximum operational speed for which the unit is designed, if this maximum speed is lower than 190 km/h). The value to be compared with the limits (see Table 1) is the maximum of the measured value at 80 km/h and the measured value taken at maximum speed but referred to 80 km/h by the equation

$$L_{pAeq,Tp}(80 \text{ km/h}) = L_{pAeq,Tp}(V) - 30 \cdot \log(V/80 \text{ km/h}).$$

#### 4.2.1.2 Limits for stationary noise

Stationary noise shall be described in terms of the A-weighted equivalent continuous sound pressure level  $L_{pAeq,T}$ .

Measurements shall be made in accordance with annex C.

The limiting value for the stationary noise of freight wagons at a distance of 7.5 m from the centre of the track and 1.2 m above top of rail is given in Table 2. The indicator for the sound pressure level is  $L_{pAeq,T}$ .

Table 2  
Limiting value  $L_{pAeq,T}$  for the stationary noise of freight wagons

Wagons	$L_{pAeq,T}$ in dB
All freight wagons	65

## 4.2.2 NOISE EMITTED BY LOCOMOTIVES, MULTIPLE UNITS, COACHES AND ON-TRACK-MACHINES (OTM).

### 4.2.2.1 Introduction

In line with clause 2.1.5, OTMs shall be assessed against the requirements for locomotives. Where applicable, the category of locomotive (electric, diesel) of which the requirements shall be used, shall correspond to the traction equipment installed in the OTM. If the OTM is diesel engine powered, it shall correspond to diesel locomotives

<sup>4</sup> TSI: Article 20 of Directive 2008/57/EC

 <b>OTIF</b>	<b>GENERAL PROVISIONS</b>		<b>UTP NOI</b>	
	<b>ROLLING STOCK – NOISE</b>		Page 11 of 48	
Status: <b>PROPOSAL</b>	Version: 01	Ref.: A 94-04/2.2011	Original: EN	Date: 11.07.2011

OTIF UTP

| Corresponding text in EU regulations <sup>1</sup> EU ref. <sup>2</sup>

with  $P \geq 2000$  kW at the engine output shaft. If the OTM is not equipped with traction equipment, measurement conditions of coach/wagon should be used (no starting noise test) but the limit values for locomotives shall be applied.

Noise emitted by locomotives, multiple units and coaches subdivides into stationary noise, starting noise, and pass-by noise. The noise within a driver's cab is a parameter for units equipped with a driver's cab.

The stationary noise is highly influenced by auxiliaries, such as cooling systems, air conditioning and compressors.

Starting noise is a combination of contributions from traction components such as diesel engines, cooling fans and auxiliaries.

Pass-by noise is highly influenced by the rolling noise, linked to the wheel/rail interaction, which is a function of Speed.

The rolling noise itself is caused by the combined wheel and rail roughness and by the dynamic behaviour of the track and wheelset.

At lower speeds the noise of auxiliaries and traction equipment is also significant.

The emitted level of noise is characterised by:

- Sound pressure level, according to a defined measuring method,
- Microphone position,
- Speed of the unit,
- Rail roughness,
- Dynamic and radiation behaviour of the track.

The parameters set for the characterisation of stationary noise comprise:

- Sound pressure level, according to a defined measuring method and microphone position,
- Operating conditions.

#### 4.2.2.2 Limits for stationary noise

The limits for stationary noise are defined at a distance of 7.5 m from the centre of the track, 1.2 m above top of rail. The indicator for the sound pressure level is  $L_{pAeq,T}$ . The limiting values for the noise emission of the vehicles under the conditions mentioned are given in Table 3.

Measurements shall be made in accordance with annex C.

Table 3

Limiting values  $L_{pAeq,T}$  for the stationary noise of electric locomotives, diesel locomotives, OTMs, EMUs, DMUs and coaches

Vehicles	$L_{pAeq,T}$ in dB
Electric locomotives and OTMs with electric traction	75
Diesel locomotives and OTMs with diesel traction	75
EMUs (Electrical Multiple Units)	68
DMUs (Diesel Multiple Units)	73
Coaches (Carriages)	65

The specified level for stationary noise is the energy-average of all measured values taken at the measuring points defined in annex C.

#### 4.2.2.3 Limits for starting noise

The limits for starting noise are defined at a distance of 7.5 m from the centre of the

 <b>OTIF</b>	<b>GENERAL PROVISIONS</b>			UTP NOI
	<b>ROLLING STOCK – NOISE</b>			Page 12 of 48
Status: <b>PROPOSAL</b>	Version: 01	Ref.: A 94-04/2.2011	Original: EN	Date: 11.07.2011

OTIF UTP

|Corresponding text in EU regulations<sup>1</sup>

EU ref.<sup>2</sup>

track, 1.2 m above top of rail.

Measurements shall be made in accordance with annex D.

For OTMs the starting procedure shall be performed without additional trailer loads. The indicator for the sound level is  $L_{pAFmax}$ . The limiting values for the starting noise of the vehicles under the conditions stated are given in Table 4.

Table 4

Limiting values  $L_{pAFmax}$  for the starting noise of electric locomotives, diesel locomotives, OTMs, EMUs and DMUs

Vehicle	$L_{pAFmax}$ in dB
Electric locomotives $P < 4500$ kW at the rail wheel	82
Electric locomotives $P \geq 4500$ kW at the rail wheel and OTMs with electric traction	85
Diesel locomotives $P < 2000$ kW at the engine output shaft	86
Diesel locomotives $P \geq 2000$ kW at the engine output shaft and OTMs with diesel traction	89
EMUs	82
DMUs $P < 500$ kW/engine	83
DMUs $P \geq 500$ kW/engine	85

#### 4.2.2.4 Limits for pass-by noise

The limits for pass-by noise are defined at a distance of 7,5 m from the centre of the track, 1,2 m above top of rail for a vehicle speed of 80 km/h. The indicator for the A weighted equivalent continuous sound level is  $L_{pAeq, Tp}$ .

Measurements shall be made in accordance with annex E.

The measured pass-by noise levels shall comply with the values as set out in Table 5 when measured on track complying with annex A. It is permitted to carry out the test on track that does not comply with annex A and if the noise levels do not exceed the values shown in Table 5, there is a presumption of conformity to this requirement.

The following conditions of the track on which the pass-by noise measurement is performed shall be measured and recorded:

- the vertical and lateral track decay rate in accordance with EN 15461
- the track acoustic roughness in accordance with EN 15610.

If the track on which the measurements were performed did meet the reference conditions as set out in annex A, or if the acceptance criterion of annex B is met, the measured values shall be marked 'comparable'. Otherwise the measured values shall be marked 'non-comparable'.

An entry shall be recorded in the technical file and in the OTIF Register of admitted types |ERATV

if the measured values are 'comparable' or 'non-comparable'. Measured values of noise as well as corresponding track quality should always be saved in the technical file for later evaluation of correspondence between vehicle and track noise for both comparable and non-comparable data.

The measured acoustic rail roughness remains valid during a period starting three months before the measurement and ending three months after the measurement, provided that during this period no track maintenance has been performed which influences the rail acoustic roughness.

The measured track decay rates remain valid during a period starting one year before the measurement and ending one year after the measurement, provided that during this period no track maintenance has been performed which influences the track decay

 <b>OTIF</b>	<b>GENERAL PROVISIONS</b>		<b>UTP NOI</b>	
	<b>ROLLING STOCK – NOISE</b>		Page 13 of 48	
Status: <b>PROPOSAL</b>	Version: 01	Ref.: A 94-04/2.2011	Original: EN	Date: 11.07.2011

OTIF UTP

|Corresponding text in EU regulations<sup>1</sup>

EU ref.<sup>2</sup>

rates.

If beyond the limits of these periods, the same stretch of track is used again for pass-by noise measurements, it is necessary to measure the acoustic roughness or decay rates again. Proof shall be provided in the technical file that the track data related to the type's pass-by noise measurement were valid during the day(s) of testing, e.g. by providing the date of last maintenance having an impact on noise.

If the maximum operational speed of the unit is lower than 80 km/h, the unit shall be tested at this maximum speed, the pass-by noise limits for 80 km/h apply without any correction. Otherwise the pass by noise of a unit shall be measured at 80 km/h and at V (where V = 190km/h, or the maximum operational speed for which the unit is designed, if this maximum speed is lower than 190 km/h). The value to be compared with the limits (see Table 5) is the greater of the measured value at 80 km/h and the measured value taken at maximum speed but normalised to 80 km/h by the equation.

$$L_{pAeq, Tp}(80 \text{ km/h}) = L_{pAeq, Tp}(V) - 30 \cdot \log(V/80 \text{ km/h}).$$

The limiting values for the noise emission of electric and diesel locomotives, EMUs, DMUs and coaches under the conditions stated above are given in Table 5. For OTMs the measuring procedure shall be performed without additional trailer loads.

Table 5

Limiting values  $L_{pAeq, Tp}$  for the pass-by noise of electric and diesel locomotives, OTMs, EMUs, DMUs and coaches

Vehicles	$L_{pAeq, Tp}$ in dB
Electric locomotives and OTMs with electric traction	85
Diesel locomotives and OTMs with diesel traction	85
EMUs	81
DMUs	82
Coaches (Carriages)	80

OTMs which are solely braked by either composite brake blocks or disc brakes are deemed to comply with the pass-by noise level requirements in table 5 without measuring. This applies also if these vehicles are equipped with composite scrubbers.

#### 4.2.3 INTERIOR NOISE OF LOCOMOTIVES, MULTIPLE UNITS AND COACHES FITTED WITH A CAB

As addressed in clause 2.1.5, OTMs shall be assessed against the requirements for locomotives.

The interior noise level of passenger vehicles is not considered to be a basic parameter. However, the noise level within the driver's cab is an important issue. Noise levels in the cab must be kept as low as possible, by limiting the noise at the source and by appropriate additional measures (acoustic insulation, sound absorption). The limiting values are defined in Table 6. For OTMs the measuring procedure shall be performed without additional trailer loads.

Measurements shall be made in accordance with annex F.

 <b>OTIF</b>	<b>GENERAL PROVISIONS</b>		<b>UTP NOI</b>	
	<b>ROLLING STOCK – NOISE</b>		Page 14 of 48	
Status: <b>PROPOSAL</b>	Version: 01	Ref.: A 94-04/2.2011	Original: EN	Date: 11.07.2011

OTIF UTP

| Corresponding text in EU regulations <sup>1</sup>

EU ref. <sup>2</sup>

Table 6

Limiting values  $L_{pAeq,T}$  for the noise within the driver's cab of electric and diesel locomotives, OTMs, EMUs, DMUs and coaches fitted with a driver's cab

Noise within the driver's cab	$L_{pAeq,T}$ in dB	Measurement time interval $T$ , in seconds
Standstill (during external acoustic warning with the maximum sound pressure of the horn, but less than 125 dB(A) at 5 m ahead of the vehicle in 1.6 m height above top of rail)	95	3
Maximum speed, applicable for speeds less than 190 km/h. (open country without interior and exterior warnings)	78	60

Note: This table applies to the driver's cab.

National rules notified according to APTU Article 12 of the admitting Contracting State(s)

on the minimum health and safety requirements regarding the exposure of workers to the risks arising from physical agents (noise) has to be applied by railway undertakings and their staff, but the compliance with those rules does not concern the technical admission of rolling stock.

In any event, Directive 2003/10/EC of the European Parliament and the Council of 6 February 2003 <sup>5</sup>

Directive 2003/10/EC

EC verification

### 4.3 FUNCTIONAL AND TECHNICAL SPECIFICATIONS OF THE INTER-FACES

This

UTP

is part of the framework of

UTPs

which set requirements to the conventional rail rolling stock subsystem.

| TSI

| TSIs

### 4.4 OPERATING RULES

In light of the essential requirements in chapter 3, there are no operating rules specific to the subsystem rolling stock regarding noise emitted by rolling stock.

### 4.5 MAINTENANCE RULES

- wheel/rail contact parameters (wheel profile),
- wheel defects (wheel flats, out of roundness).

See maintenance file, which is specified in the conventional rail rolling stock UTPs.

| TSIs.

### 4.6 PROFESSIONAL QUALIFICATIONS

There are no additional requirements to existing

<sup>5</sup> EU Official Journal no L 42 of 15.02.2003, p. 38.

 <b>OTIF</b>	<b>GENERAL PROVISIONS</b>		<b>UTP NOI</b>	
	<b>ROLLING STOCK – NOISE</b>		Page 15 of 48	
Status: <b>PROPOSAL</b>	Version: 01	Ref.: A 94-04/2.2011	Original: EN	Date: 11.07.2011

OTIF UTP

national regulations  
on professional qualifications.

Corresponding text in EU regulations<sup>1</sup> EU ref.<sup>2</sup>  
European legislation and national ones  
compatible with European legislation

#### 4.7 HEALTH AND SAFETY CONDITIONS

Lower exposure action values contained in national regulations shall be deemed to be

The lower exposure action values set up in Article 3 of Directive 2003/10/EC (17th individual directive within the meaning of Article 16(1) of Directive 89/391/EEC<sup>6</sup>) are

met with the present limits of interior noise in drivers' cabs:

- as regards peak values,
- and generally as regards average values, for standard operational conditions.

#### 4.8 INFRASTRUCTURE AND REGISTER OF ADMITTED TYPES | ROLLING STOCK REGISTERS

##### 4.8.1 Infrastructure register

Not applicable to this UTP.

TSI.

##### 4.8.2 Register of admitted types

Rolling stock register

As far the subsystem rolling stock regarding noise emitted by rolling stock is concerned, the following information shall be included in the

Register of admitted types:

Rolling Stock Register:

- pass-by noise (basic parameters 4.2.1.1 and 4.2.2.4), accompanied by information on the rail acoustic roughness and vertical and lateral decay rates for the track on which the measurement was performed. This information shall indicate whether or not the measured values are 'comparable' or 'non-comparable' as defined in clauses 4.2.1.1 and 4.2.2.4 regarding pass-by noise,
- stationary noise (basic parameters 4.2.1.2 and 4.2.2.2),
- starting noise (basic parameters 4.2.2.3),
- interior noise in the driver's cab.

### 5. INTEROPERABILITY CONSTITUENTS

There are no interoperability constituents specified in this UTP.

TSI.

<sup>6</sup> EU Official Journal no L 183 of 29.06.1989, p. 1.

 <b>OTIF</b>	<b>GENERAL PROVISIONS</b>		<b>UTP NOI</b>	
	<b>ROLLING STOCK – NOISE</b>		Page 16 of 48	
Status: <b>PROPOSAL</b>	Version: 01	Ref.: A 94-04/2.2011	Original: EN	Date: 11.07.2011

OTIF UTP

|Corresponding text in EU regulations<sup>1</sup>

EU ref.<sup>2</sup>

## 6. ASSESSMENT OF CONFORMITY OF THE SUBSYSTEM WITH THIS UTP AND/OR SUITABILITY FOR USE OF THE CONSTITUENTS AND VERIFICATIONS OF THE SUBSYSTEM

### 6.1 INTEROPERABILITY CONSTITUENTS

Not applicable.

### 6.2 SUBSYSTEM ROLLING STOCK REGARDING NOISE EMITTED BY ROLLING STOCK

#### 6.2.1 ASSESSMENT PROCEDURES

At the request of the applicant, an assessing entity (see definition in UTP GEN-D) shall carry out

the assessment in accordance with UTP GEN-D.

Assessment of the subsystem's compliance with the requirements of this UTP NOI cannot result in a Technical Certificate (Design Type Certificate and/or Certificate of Operation), but a positive result shall be included in the Type examination certificate required in point 6 of module SB in UTP GEN-D or the Design type examination certificate required in point 4.4 of module SH1, if that module is applied.

a notified body

the EC verification in accordance with Annex VI to Directive 2008/57/EC.

The contracting entity shall draw up the EC declaration of verification for the rolling stock subsystem including the noise aspect in accordance with Article 18(1) and Annex V to Directive 2008/57/EC.

#### 6.2.2 MODULES

For the assessment of the noise requirements, as specified in chapter 4, the applicant is permitted to choose the following modules:

|For the verification procedure

- a) the "Type Examination" procedure (module SB) for the design and development phase, in combination with a module for the production phase either:
  - the "Quality Management System of the production process" procedure (module SD), or
  - the "Product Verification" procedure (module SF);

or

- b) the "Full quality Management System with Design Examination" procedure (module SH1).

The module SD is permitted only to be chosen where the applicant operates

|contracting entity, or the main contractors when involved, operate

 <b>OTIF</b>	<b>GENERAL PROVISIONS</b>		<b>UTP NOI</b>	
	<b>ROLLING STOCK – NOISE</b>		Page 17 of 48	
Status: <b>PROPOSAL</b>	Version: 01	Ref.: A 94-04/2.2011	Original: EN	Date: 11.07.2011

OTIF UTP

| Corresponding text in EU regulations <sup>1</sup> EU ref. <sup>2</sup>

a quality management system for manufacture, final production, inspection and testing, approved and surveyed by

a competent authority, a suitable body or a “notified body” in a Contracting State of its choice. | a Notified Body of his/their choice.

The module SH1 is permitted only to be chosen where the applicant operates

| contracting entity, or the main contractors when involved,

a quality management system for design, manufacture, final production inspection and testing, approved and surveyed by

a competent authority, a suitable body or a “notified body” in a Contracting State of its choice. | a notified body of their choice.

## 6.2.3 ASSESSMENT (VERIFICATION) METHODS SPECIFIC TO NOISE ASPECTS OF ROLLING STOCK

### 6.2.3.1 Introduction

Notwithstanding the exemptions as described in this section, by default all new types need to be assessed in compliance with the requirements specified in chapter 4 of this UTP | TSI

Instead of the test procedures as set out in chapter 4 of this UTP, it is | TSI, it may be

permitted to substitute some or all of the tests by a simplified evaluation method. The eligibility criteria and requirements associated to the simplified evaluation method are set out in this section.

The simplified evaluation method consists of acoustically comparing the type under assessment to an existing type with documented noise characteristics compliant with the noise

UTP; | TSI; the latter is further referred to as the reference type.

It is permitted to substitute noise testing by a simplified evaluation, if the type under assessment is comparable to a reference type which has been tested in compliance with one of the following:

a) Chapter 4 of this UTP | TSI and for which the pass-by noise results are marked ‘comparable’, or

b) in compliance with chapter 4 of the TSI CR “rolling stock — noise” in the version adopted by European Commission Decision 2006/66/EC <sup>7</sup>.

The following units are eligible for a simplified evaluation:

a) Different formations of multiple units,

b) Renewed or upgraded units in accordance with point 7.6 of this UTP, | TSI,

c) New units which are largely based on an existing design (same vehicle family).

For the units under assessment for simplified evaluation, the proof of conformity shall include a detailed description of the noise relevant changes compared to the reference type. From this description, a simplified evaluation (see points 6.2.3.2 and 6.2.3.3) shall be performed to identify the differences in terms of expected noise emission, of the noise cases specified in point 4.2 between the reference unit and the unit under

<sup>7</sup> EU Official Journal L37, 08.02.2006, p. 1-49

 <b>OTIF</b>	<b>GENERAL PROVISIONS</b>		<b>UTP NOI</b>	
	<b>ROLLING STOCK – NOISE</b>		Page 18 of 48	
Status: <b>PROPOSAL</b>	Version: 01	Ref.: A 94-04/2.2011	Original: EN	Date: 11.07.2011

OTIF UTP

|Corresponding text in EU regulations<sup>1</sup>

EU ref.<sup>2</sup>

assessment.

The simplified evaluation may be used on a unit for each of the individual noise cases autonomously: stationary noise, starting noise, cab-noise and pass-by noise.

#### 6.2.3.2 Simplified evaluation for locomotives, multiple units, coaches and OTMs

The simplified evaluation shall prove that the unit under assessment complies with the applicable noise levels as set out in this

UTP,

|TSI,

for those noise cases for which the simplified evaluation is used.

The simplified evaluation on a unit shall consist of providing evidence to show that the acoustically relevant systems and characteristics are either identical to those of the reference type, or such that they will not result in higher noise emission of the unit under assessment. The simplified evaluation can either be a calculation, or simplified measurement (e.g. sound power of noise sources), or a combination of both. Noise relevant systems which differ from the reference type shall be identified in the technical file.

#### 6.2.3.3 Simplified evaluation for freight wagons

For upgraded or renewed wagons, also see clause 7.6.1. In case additional conformity assessment is needed and where Table 7 is complied with, the simplified evaluation method is permitted to be used for upgraded or renewed freight wagons.

For new wagons: in cases where Table 7 is complied with, the simplified evaluation method is permitted to be used for freight wagons.

 <b>OTIF</b>	<b>GENERAL PROVISIONS</b>			UTP NOI
	<b>ROLLING STOCK – NOISE</b>			Page 19 of 48
Status: <b>PROPOSAL</b>	Version: 01	Ref.: A 94-04/2.2011	Original: EN	Date: 11.07.2011

OTIF UTP

|Corresponding text in EU regulations<sup>1</sup>

EU ref.<sup>2</sup>

Table 7

List of noise relevant parameters for freight wagons and their permitted variation from a 'reference type' configuration

Unit parameter	Permitted variation	Applies for:	
		Stationary noise	Pass-by noise
Max unit speed	Up to 10 km/h increase allowed compared to the reference type	—	+
Type of wheel	Allowed if less noisy than the reference type's wheel type (acoustic characterisation of the wheels as set out in Annex E of EN 13979-1)	—	+
Number of axles per unit length (related to either the length of the wagon or the number of wheelsets)	Allowed, if lower than reference type	—	+
Tare weight	Change ± 5% allowed compared to the reference type	—	+
Brake system	No change allowed compared to the reference type	—	+
Class of wagon (e.g. tank, hopper, van, platform)	No change of class allowed compared to the reference type	+	+
Auxiliary equipment	No restriction	+	—

If the simplified evaluation is permitted to be used:

- The pass-by noise levels as set out in clause 4.2.1.1 are deemed to be compliant without testing.
- For stationary noise, the simplified evaluation shall consist of providing evidence to show that the acoustically relevant systems and characteristics are either identical to those of the reference type, or such that they will not result in higher noise emission of the unit under assessment. The simplified evaluation can either be a calculation, or simplified measurement (e.g. sound power of noise sources), or a combination of both. Noise relevant systems which differ from the reference type shall be identified in the technical file.

#### 6.2.4 UNITS CERTIFIED IN ACCORDANCE WITH THE EU HIGH-SPEED ROLLING STOCK TSI (HS RST TSI) | UNITS REQUIRING EC CERTIFICATION AGAINST THE HS RST TSI AND AGAINST THIS TSI

When a unit has been positively assessed against the EU High-speed Rolling Stock TSI (HS RST TSI), it is deemed to comply with the requirements in this

UTP

| TSI

without further checks,

provided the vehicle is not subject to any

| In this case, the applicant may issue its EC declaration without further evaluation.

 <b>OTIF</b>	<b>GENERAL PROVISIONS</b>		<b>UTP NOI</b>	
	<b>ROLLING STOCK – NOISE</b>		Page 20 of 48	
Status: <b>PROPOSAL</b>	Version: 01	Ref.: A 94-04/2.2011	Original: EN	Date: 11.07.2011

OTIF UTP

Corresponding text in EU regulations <sup>1</sup> EU ref. <sup>2</sup>

derogations relating to noise aspects. This is only permitted if there are no

## 7. IMPLEMENTATION

### 7.1 GENERAL

The implementation of the UTPs must take into consideration the overall migration of the conventional rail network towards full interoperability.

TSIs

In order to support this migration, the UTPs allow for staged, gradual application and coordinated implementation with other UTPs.

TSIs

TSIs.

### 7.2 REVISION OF UTP

### TSI REVISION

The Committee of Technical Experts shall be responsible for reviewing and updating this and related UTPs

In conformity with article 6(2) of Directive 2008/57/EC, the Agency shall be responsible for preparing the review and updating of TSIs and making appropriate recommendations to the Commission

in order to take account of developments in technology or social requirements. In addition, the progressive adoption and revision of other UTPs may also impact this UTP.

TSIs

TSI.

Proposed changes to this UTP shall be subject to rigorous review and updated UTPs will be published on an indicative periodic basis of 3 years.

TSI

TSIs

The Secretary General shall be notified of any innovative solutions under consideration in order to determine their future inclusion in the UTP.

In the first revision, the Committee of Technical Experts should consider

In any case the Commission will deliver to the Committee referred to in Article 29 of Directive 2008/57/EC (also referred to as the "RIS Committee", at the latest by 23 June 2013, a report and, if needed, a proposal for revising this TSI with regard to

the following issues:

- an assessment of the implementation of the UTP, in particular costs and benefits;
- the use of a continuous curve of limiting values  $L_{pAeq,Tp}$  for the pass-by noise of freight wagons as a function of APL (axles per length), provided that it does not prevent technical innovation, in particular for rakes of wagons;
- the second step pass-by noise limit values for wagons, locomotives, multiple units and coaches (see point 7.3), according to the results of comparable noise measurement campaigns, taking into account in particular technical progress and avail-

TSI

 <b>OTIF</b>	<b>GENERAL PROVISIONS</b>		<b>UTP NOI</b>	
	<b>ROLLING STOCK – NOISE</b>		Page 21 of 48	
Status: <b>PROPOSAL</b>	Version: 01	Ref.: A 94-04/2.2011	Original: EN	Date: 11.07.2011

OTIF UTP | Corresponding text in EU regulations <sup>1</sup> | EU ref. <sup>2</sup>

able technologies for both track and rolling stock and cost-benefit analyses;

- d) a possible second-step starting noise limit values for diesel locomotives and multiple units;
- e) the inclusion of infrastructure into the scope of the  
UTP Noise | TSI Noise  
in coordination with the  
UTP Infrastructure; | TSI Infrastructure;
- f) the inclusion of infrastructure in the  
UTP Noise | TSI Noise  
of a monitoring scheme for wheel defects. Wheel defects have an impact on noise emission.

### 7.3 A TWO STEP APPROACH

It is recommended that in the case of new rolling stock to be ordered after 5 years after the entry into force of this UTP | 23 June 2016, or authorised to be placed into service after 23 June 2018, points 4.2.1.1 and 4.2.2.4 of this UTP | TSI are applied with a reduction of 5 dB except for DMUs and EMUs. For both latter cases the reduction is 2 dB. This recommendation will serve only as a basis for revising points 4.2.1.1 and 4.2.2.4 in the context of the UTP | TSI revision process mentioned in point 7.2.

### 7.4 RETROFITTING PROGRAMME FOR NOISE REDUCTION

There are no retrofitting requirements in this UTP. However, a Contracting State may adopt a mandatory retrofitting programme for vehicles registered in their National Vehicle Register (NVR) in order that those vehicles will meet the requirements of this UTP within a specific time-scale. | Given the long life-cycle of railway vehicles it is also necessary to take measures on the existing fleet of rolling stock, with priority for freight wagons, to foster a noticeable reduction of the perceived noise level within a reasonable time period. The Commission will take initiatives to discuss options for retrofitting of freight wagons with the relevant stakeholders to achieve a general agreement with the industry.

### 7.5 APPLICATION OF THIS UTP TO NEW ROLLING STOCK

The specifications provided by this UTP | TSI apply to all new rolling stock within the scope of this UTP. | TSI.

#### 7.5.1 Starting noise

The starting noise limits may be raised by 2 dB for all DMUs, with an engine power greater than 500 kW/engine, authorised to be placed into service by no later than 2 years after the entry into force of this UTP. | by 23 June 2011 at the latest.

#### 7.5.2 Exceptions for national, bilateral, multilateral or multinational agreements

##### 7.5.2.1 Existing agreements

 <b>OTIF</b>	<b>GENERAL PROVISIONS</b>		<b>UTP NOI</b>	
	<b>ROLLING STOCK – NOISE</b>		Page 22 of 48	
Status: <b>PROPOSAL</b>	Version: 01	Ref.: A 94-04/2.2011	Original: EN	Date: 11.07.2011

OTIF UTP

<p>Existing agreements between Contracting States and agreements with other States having a track gauge of 1520 mm notified to the Secretary General shall remain in force until the Committee of Technical Experts decides otherwise.</p>	<p><i>Corresponding text in EU regulations</i><sup>1</sup> <i>EU ref.</i><sup>2</sup></p> <p>Where notified agreements contain requirements related to noise, these agreements remain permitted until the necessary measures are taken including EU level agreements related to this TSI with the Russian Federation and all the other CIS countries having a border with the EU.</p>
--	---

**7.5.2.2 Future agreements or modification of existing agreements**

<p>Any future agreement or modification of existing agreements shall take into account COTIF regulations and, in particular this UTP.</p> <p>Before their conclusion, Contracting States shall notify the Secretary General of such agreements/modifications. The Committee of Technical Experts will check their compatibility with the COTIF regulations, including this UTP, and will include, for example, possible specific cases or transitional measures the next time this UTP is revised.</p>	<p>EU legislation</p> <p>TSI.</p> <p>Member States shall notify the Commission with</p>
--	---

**7.6 APPLICATION OF THIS UTP TO EXISTING ROLLING STOCK**

UTP

**7.6.1 Renewal or upgrading of existing freight wagons**

<p>In the case of renewal or upgrading of freight wagons the Contracting State has to decide in accordance with ATMF Article 10 § 11, if a new technical admission is needed.</p> <p>If the performance of the brake system of this wagon is changed by the renewal or upgrading and if a new technical admission is needed, the requirement is that the pass-by level of this wagon shall comply with the relevant level indicated in Table 1 of point 4.2.1.1.</p> <p>If a wagon during renewal or upgrading is being equipped (or is already equipped) with composite blocks and without adding additional noise sources to the wagon, it shall be assumed without testing that the values of point 4.2.1.1 are fulfilled.</p> <p>An upgrading for noise emission reduction only is not mandatory, but if upgrading is done for another reason it shall be demonstrated that renewal or upgrading does either not increase pass-by noise levels, or when increased remain within the limits which are specified in this UTP.</p> <p>For stationary noise, it shall be demonstrated that the stationary noise levels do either not increase, or when increased remain within the limits which are specified in this UTP.</p> <p>As an alternative to full vehicle measurement, the demonstration of compliance of a unit is permitted to be performed by an evaluation under the conditions as defined in clause 6.2.3 of this UTP.</p>	<p>the Member State, has</p> <p>Article 20 of Directive 2008/57/EC, if a new authorisation for placing into service</p> <p>authorisation for placing into service</p> <p>TSI.</p> <p>TSI.</p> <p>TSI.</p>
---	---

 <b>OTIF</b>	<b>GENERAL PROVISIONS</b>		<b>UTP NOI</b>	
	<b>ROLLING STOCK – NOISE</b>		Page 23 of 48	
Status: <b>PROPOSAL</b>	Version: 01	Ref.: A 94-04/2.2011	Original: EN	Date: 11.07.2011

OTIF UTP

|Corresponding text in EU regulations<sup>1</sup>

EU ref.<sup>2</sup>

In this case the unit before upgrade shall act as the reference unit.

### 7.6.2 **Renewal or upgrading of locomotives, multiple units, coaches and OTMs**

It shall be demonstrated that the noise levels of renewed or upgraded units are either not increased, or when increased remain within the limits which are specified in this UTP. |TSI.

The demonstration of compliance of a unit can, as an alternative to full vehicle measurement, also be done by an evaluation under the conditions as defined in clause 6.2.3 of this UTP. |TSI.

In this case the unit before upgrade shall act as the reference unit.

## 7.7 **SPECIFIC CASES**

The specific cases included in UTP Noise shall apply in common to EU and OTIF.

### 7.7.1 **Introduction**

The following special provisions shall apply in the specific cases below.

Specific cases belong to two categories: the provisions apply either permanently (case P), or temporarily (case T). In temporary cases, it is recommended that the Contracting States which are not subject to the EU legislation concerned should

fully apply the specifications set out in chapter 4 and the provisions in section 7.5 and 7.6 within 2 years (case T1) and within 10 years (case T2) after the entry into force of this UTP, at the latest.

Contracting States which are subject to EU law shall apply the EU recommendations.

Member States conform with the relevant subsystem either by 2010 (case T1), an objective set out in Decision 1692/96/EC of the European Parliament and of the Council of 23 July 1996 on Community guidelines for the development of the trans-European transport network<sup>8</sup>, or by 2020 (case T2).

### 7.7.2 **List of specific cases**

#### 7.7.2.1 *Limit for stationary noise, "strictly for use on the UK and Ireland networks only"*

Category P - permanent

Table 8

Limiting values  $L_{pAeq,T}$  for the stationary noise of DMUs

Vehicles	$L_{pAeq,T}$ in dB
DMUs	77

#### 7.7.2.2 *Finland*

Category P – permanent

The application of national technical rules instead of the requirements in this TSI is permitted for third countries' rolling stock to be used on the Finnish 1524 mm network in traffic between Finland and third countries' 1520 mm network.

Category T1 – temporary

In the territory of Finland, the limits for stationary noise in point 4.2.1.2 shall not be applied to wagons equipped with a diesel aggregate for electrical power supply higher than 100 kW when the aggregate is used. In this case the stationary noise limit may be

<sup>8</sup> Official Journal of EU no L 228 of 09.09.1996, p.1.

 <b>OTIF</b>	<b>GENERAL PROVISIONS</b>		<b>UTP NOI</b>	
	<b>ROLLING STOCK – NOISE</b>		Page 24 of 48	
Status: <b>PROPOSAL</b>	Version: 01	Ref.: A 94-04/2.2011	Original: EN	Date: 11.07.2011

OTIF UTP

| Corresponding text in EU regulations <sup>1</sup> EU ref. <sup>2</sup>

raised by 7 dB due to the temperature range down to - 40 °C together with freezing and icy conditions.

**7.2.2.3** *Limits for starting noise, "strictly for use on the UK and Ireland networks only"*

Category P – permanent

Table 9

Limiting values  $L_{pAFmax}$  for the starting noise of electric locomotives, diesel locomotives and DMUs

Vehicles	$L_{pAFmax}$ in dB
Electric locomotives less than 4500 kW at the rail wheel	84
Diesel locomotives less than 2000 kW at the engine output shaft	89
DMUs $P < 500$ kW/engine	85

**7.7.2.4** *Limits for pass-by noise for freight wagons, in Finland, Norway, Estonia, Latvia and Lithuania*

Category T1 – temporary

The noise emission limits for freight wagons are not valid for Finland, Norway, Estonia, Latvia and Lithuania. The reason for this is the safety aspects under Nordic winter conditions. This specific case is valid until the functional specification and assessment method for composite brake blocks are incorporated in the revised version of the WAG TSI.

That does not preclude freight wagons from other Contracting States | EU Member States from operating in Nordic and Baltic States.

**7.7.2.5** *Specific case for Greece*

Category T1 – temporary: Rolling stock for track gauge 1000 mm or less.

For the existing isolated 1000 mm gauge, national rules shall apply.

**7.7.2.6** *Specific case for Estonia, Latvia and Lithuania*

Category T1 – temporary

The noise emission limits for all rolling stock (locomotives, coaches, EMUs and DMUs) are not valid for Estonia, Latvia and Lithuania until the revision of the TSI Noise.

this TSI.

In the meantime, measurement campaigns will be carried out in these States; the revision of this TSI shall take into account the results of these campaigns.

**7.7.2.7** *Specific cases for non-EU OTIF Contracting States*

Specific cases for Contracting States which are not Member States of the European Union will be included in this UTP when they have been evaluated and adopted by the Committee of Technical Experts.

## ANNEX A: REFERENCE TRACK DEFINITION

The reference track shall comply with the following requirements:

### A.1 RAIL ACOUSTIC ROUGHNESS OF THE TEST TRACK

The condition of the rail acoustic roughness shall be considered suitable for comparable measurements if the one-third octave band roughness spectra assessed according to EN15610 throughout the test section fulfil the following upper limit taking into account, if necessary, the flexibility process described in Annex B. The wavelength bandwidth should be at least 0.003 m to 0.10 m (0.3 cm to 10.0 cm corresponding to **Figure A.1**).

Figure A.1

Upper limit curve for the acoustic rail roughness

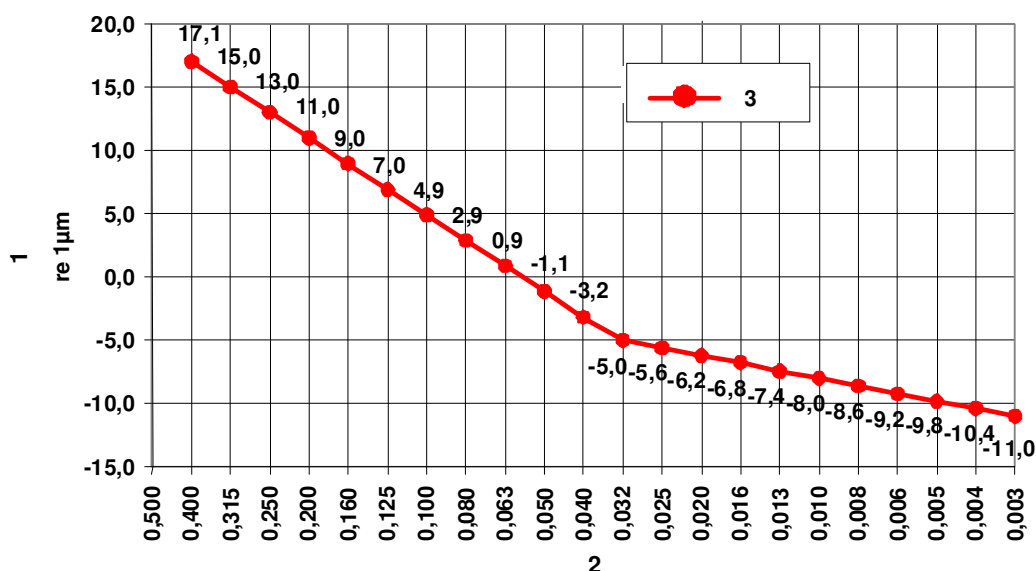

Key: 1 = 1/3 octave band roughness level, dB

2 = wavelength, m

3 = UTP upper limit, 1/3 octave band roughness level, dB

### A.2 DYNAMIC PROPERTIES OF THE TEST TRACK

The condition of the dynamic properties of the track shall be considered suitable for comparable measurements if the one-third octave band track decay rates spectra measured according to EN15461 throughout the test section fulfil the following lower limits:

OTIF UTP

|Corresponding text in EU regulations<sup>1</sup>

EU ref.<sup>2</sup>

Figure A.2

Lower limit curves for the track decay rates

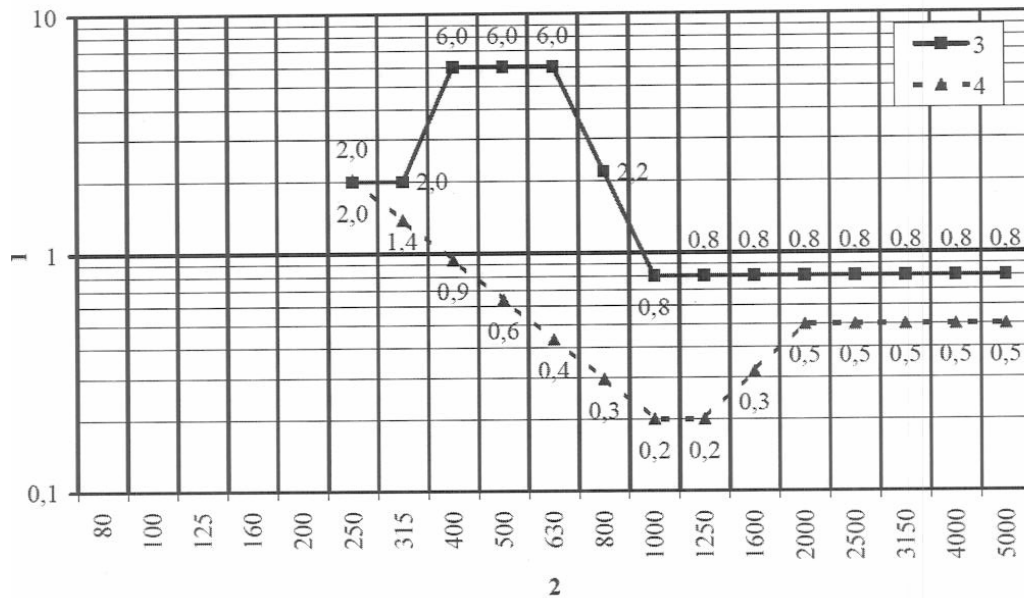

- Key:
- 1 = Track decay rate, dB/m
  - 2 = Frequency, Hz
  - 3 = TDR limit in the vertical direction
  - 4 = TDR limit in the lateral direction

 <b>OTIF</b>	<b>GENERAL PROVISIONS</b> <b>ROLLING STOCK – NOISE</b>		UTP NOI Page 27 of 48
	Status: <b>PROPOSAL</b>	Version: 01	Ref.: A 94-04/2.2011

OTIF UTP

|Corresponding text in EU regulations<sup>1</sup>

EU ref.<sup>2</sup>

## ANNEX B: SMALL DEVIATION CALCULATION METHOD

### Method to assess acceptable small deviations from rail roughness requirements

#### B.1 PRINCIPLE

The "small deviations" method aims at introducing some flexibility in the conformity assessment of a test track section towards a limit curve of acoustic rail roughness within the frame of constant speed tests. Both the limit curve and the measured acoustic rail roughness spectra are assumed to be one third octave band wavelength spectra.

Deviations to the track decay rates are not acceptable under the Small deviation calculation method.

The method relies on a calculation of a correction to the measured level based on the effect of any exceeding of a specified spectrum of acoustic rail roughness. The difference between the corrected pass-by noise level and the measured one is then compared to an acceptance criterion.

If the criterion is fulfilled, the acoustic impact of the rail roughness deviations is deemed 'small' and the measured pass-by noise level is considered to be comparable.

This method is train speed dependent.

#### B.2 PROCESSING

##### B.2.1 GENERATE A 'JUST COMPLIANT' CORRECTED SPECTRUM FROM THE MEASURED ACOUSTIC RAIL ROUGHNESS WAVELENGTH SPECTRUM (STEP 1)

The measured rail acoustic roughness spectra shall be energetically averaged. A corrected spectrum shall be derived from the measured acoustic rail roughness wavelength spectrum and from the limit spectrum according to the following formula:

$$\tilde{L}_{r,rail}^{corrected}(\lambda) = \min[\tilde{L}_{r,rail}^{measured}(\lambda), \tilde{L}_{r,rail}^{limit}(\lambda)]$$

where

$\tilde{L}_{r,rail}^{measured}(\lambda)$  is the one-third octave band wavelength spectrum of the measured acoustic rail roughness;

$\tilde{L}_{r,rail}^{limit}(\lambda)$  is the one-third octave band wavelength limit spectrum;

$\tilde{L}_{r,rail}^{corrected}(\lambda)$  is the one-third octave band wavelength limit spectrum of the corrected acoustic rail roughness

NOTE 1: The corrected acoustic rail roughness spectrum is equivalent to the measured one except in the wavelength bands where the measured spectrum exceeds the limits.

NOTE 2: The corrected acoustic rail roughness spectrum complies with the limit spectrum

 <b>OTIF</b>	<b>GENERAL PROVISIONS</b>		<b>UTP NOI</b>	
	<b>ROLLING STOCK – NOISE</b>		Page 28 of 48	
Status: <b>PROPOSAL</b>	Version: 01	Ref.: A 94-04/2.2011	Original: EN	Date: 11.07.2011

OTIF UTP

|Corresponding text in EU regulations<sup>1</sup>

EU ref.<sup>2</sup>

## B.2.2 QUANTIFY THE DEVIATIONS IN THE RAIL ROUGHNESS FREQUENCY SPECTRUM (STEP 2)

Transform the one-third octave band wavelength spectra (corrected and measured acoustic rail roughnesses) into the frequency domain to synthesize one-third octave band frequency spectra compliant with EN 61260. This shall be carried out in two stages:

- First derive frequencies from wavelengths using the formula  $f = V/\lambda$  where  $\lambda$  is the wavelength and  $f$  is the corresponding frequency at train speed  $V$ . This leads to a non-normalized one-third octave frequency roughness spectrum.
- Then distribute the energy in each frequency band over the normalized ones according to the algorithm supplied in annex C of EN15610.

The Impact of the deviations on the acoustic rail roughness frequency spectrum is then quantified through a correcting spectrum which is calculated as follows:

$$\Delta L_{r,rail}(f) = L_{r,rail}^{measured}(f) - L_{r,rail}^{corrected}(f)$$

where

$L_{r,rail}^{measured}(f)$  is the one-third octave frequency spectrum of the measured rail acoustic roughness;

$L_{r,rail}^{corrected}(f)$  is the one-third octave frequency spectrum of the corrected rail acoustic roughness;

$\Delta L_{r,rail}(f)$  is the one-third octave frequency correcting spectrum

## B.2.3 CALCULATE A REVISED NOISE SPECTRUM (STEP3)

A revised noise spectrum shall be calculated from the measured noise level and the correcting roughness spectrum according to the following formula:

$$L_{pAeq,Tp}^{revised}(f) = L_{pAeq,Tp}^{measured}(f) - \Delta L_{r,rail}(f)$$

The revised noise spectrum is derived from a simplified process. This procedure shall not be used as a prediction method to correct noise levels.

NOTE Since it has been assumed in the method of calculation that the rail roughness exceeding directly applies to the total noise, the revised noise spectrum is the minimum that might have been measured with the just compliant roughness spectrum.

An upper bound of the noise impact of the rail roughness deviations shall then be derived from the measured and revised noise spectra by:

$$\Delta L_{pAeq,Tp} = \bigoplus_i \{ L_{pAeq,Tp}^{measured}(f_i) \} - \bigoplus_i \{ L_{pAeq,Tp}^{corrected}(f_i) \}$$

where  $\bigoplus_i \{ \}$  stands for the dB sum of all the one-third octave frequency bands  $i$ .

## B.3 ACCEPTANCE CRITERION

The track shall be considered to be compliant regarding the acoustic rail roughness spectrum if the noise impact  $\Delta L_{pAeq,Tp}$  calculated according to step 3 is less than or equal to 1 dB.

 <b>OTIF</b>	<b>GENERAL PROVISIONS</b> <b>ROLLING STOCK – NOISE</b>			UTP NOI Page 29 of 48
Status: <b>PROPOSAL</b>	Version: 01	Ref.: A 94-04/2.2011	Original: EN	Date: 11.07.2011

OTIF UTP

| *Corresponding text in EU regulations*<sup>1</sup>

*EU ref.*<sup>2</sup>

This compliance shall be examined for one pass-by at each speed.

 <b>OTIF</b>	<b>GENERAL PROVISIONS</b>		<b>UTP NOI</b>	
	<b>ROLLING STOCK – NOISE</b>		Page 30 of 48	
Status: <b>PROPOSAL</b>	Version: 01	Ref.: A 94-04/2.2011	Original: EN	Date: 11.07.2011

OTIF UTP

|Corresponding text in EU regulations<sup>1</sup>

EU ref.<sup>2</sup>

## **ANNEX C: MEASUREMENT DETAILS FOR STATIONARY NOISE MEASUREMENTS**

### **Stationary test**

#### **C.1 GENERAL**

The measurements shall be carried out only if noise sources are present at standstill with the operating conditions specified under the heading “Vehicle conditions” in this annex.

#### **C.2 ENVIRONMENTAL CONDITIONS**

##### **C.2.1 ACOUSTICAL ENVIRONMENT**

In the triangular area between the track and the microphone extending along the track to a distance twice the microphone distance to either side, the test site shall be such that free sound propagation exists. To achieve this result, then:

- the level of the ground surface over this area shall be within +0 m to -2 m, relative to the top of rail;
- this area shall be free of sound absorbing matter (e.g. lying snow, tall vegetation) or reflective covering (e.g. water, ice, tarmac or concrete);
- no person shall be present in this area, and the observer shall be in a position that does not influence the measured sound pressure level significantly;
- the presence of other tracks is permissible in this area as long as the ballast bed height does not exceed the height of the rail surface of the test track.

Additionally, an area around the microphones having a radius which is at least 3 times the measurement distance shall be free of large reflecting objects like barriers, hills, rocks, bridges or buildings.

##### **C.2.2 BACKGROUND SOUND PRESSURE LEVEL**

Care shall be taken to ensure that the noise from other sources (for example other vehicles or industrial plants and due to wind) does not influence significantly the measurements.

The maximum value of the  $L_{Aeq,T}$  where  $T = 20$  sec of background noise over all microphone positions shall be at least 10 dB below the final result (energy-mean of all the measuring positions, see under heading 'Measurement mesh' in this annex) obtained when measuring the noise from the unit in the presence of background noise.

#### **C.3 TRACK CONDITIONS**

The measurements shall be made on track with ballast bed.

#### **C.4 VEHICLE CONDITIONS**

##### **C.4.1 GENERAL**

Air management systems, including grilles, filters and fans, shall be clear of any obstruction.

During the measurements, the doors and windows of the unit shall be kept closed.

 <b>OTIF</b>	<b>GENERAL PROVISIONS</b>		<b>UTP NOI</b>	
	<b>ROLLING STOCK – NOISE</b>		Page 31 of 48	
Status: <b>PROPOSAL</b>	Version: 01	Ref.: A 94-04/2.2011	Original: EN	Date: 11.07.2011

OTIF UTP

|Corresponding text in EU regulations<sup>1</sup>

EU ref.<sup>2</sup>

## C.4.2 NORMAL OPERATING CONDITIONS

The measurements shall be carried out in normal operating conditions defined as follows:

All equipment that operates continuously when the unit is stationary shall be operating at normal load, which is the performance at an external temperature of 20°C. For HVAC systems conditioning passenger areas and working places as well as system supplying energy for this function, climate influence parameters shall be set at: wind speed at 3 m/sec, relative humidity at 50 %, 700 W/m<sup>2</sup> energy from sun radiation, one person per seat and a constant interior temperature of 20°C.

Traction equipment shall be in a stationary thermal condition with cooling equipment working at minimum condition. For units with internal combustion engines, the engine shall idle.

## C.5 MEASUREMENT POSITION

### C.5.1 MEASUREMENT MESH

Each vehicle (a multiple unit comprises a number of vehicles) shall be divided into equally distributed areas, each having an identical horizontal length  $l_x$  between 3 m and 5 m. The length of the vehicle is the distance between couplers or buffers. Each measurement position is located at midlength along the relevant area on both sides of the vehicle. Extra measurement positions shall be taken at the front and rear end of the unit: two microphones located at 60° from the centre of the track, on a half circle having its centre in the midpoint of the unit end (without couplers or buffers) and a radius equal to 7.5 m as illustrated in **Figure C.3**. In the case of a trailer unit these extra positions shall be measured only at ends which are equipped with a cab.

Each measurement position shall be located at a distance of 7.5 m from the centre line of the track at a height of 1.2 m above top of rail and opposite the centre of the unit.

The microphone axis shall be horizontal and directed perpendicularly to the contour of the unit.

### C.5.2 REDUCTION OF THE NUMBER OF MEASUREMENT POSITIONS

Redundant measurements may be omitted, considering that some measurement positions are equivalent (and will lead to similar noise levels), in the following cases:

- If both sides of the unit are identical (axisymmetric or point symmetric) then it is permissible to omit the measurement points on one side of the unit.
- If several vehicles of the same type are present within a multiple unit or a fixed formation train, it is permissible to measure each type of vehicle once.

The reduction of the number of measurement positions shall be justified in the report. Omitted points shall be listed and their assumed equivalent location identified.



Figure C.3

Example of a mesh of measurement positions for the stationary noise measurement of a multiple unit. Each of the vehicle a, b, and c is divided up into equally distributed areas, each having a length equal to  $l_a/5$ ,  $l_b/4$  and  $l_c/4$  of between 3 m and 5 m respectively.

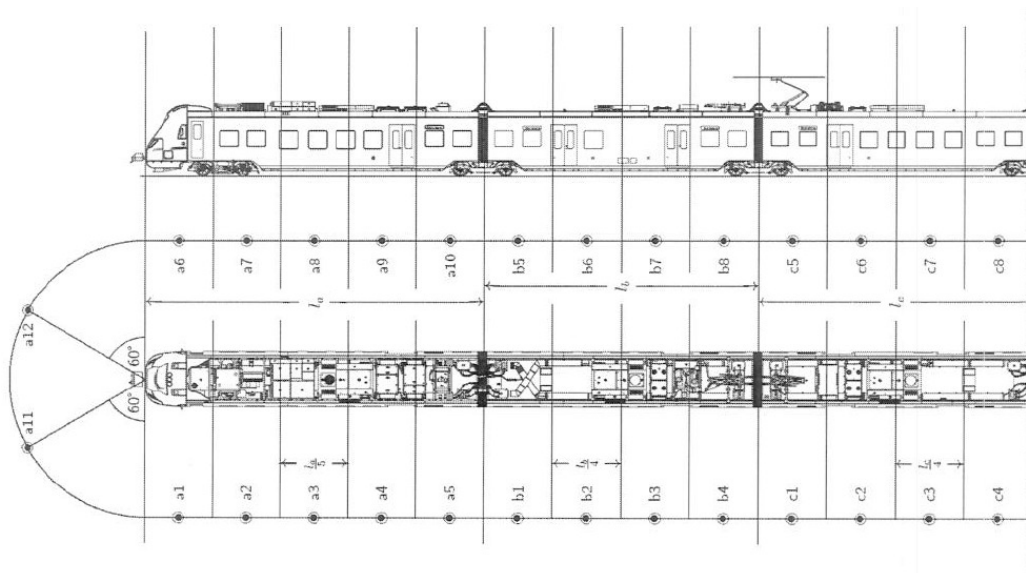

## C.6 MEASURED QUANTITIES

The measured acoustic quantity is  $L_{pAeq,T}$  with  $T = 20$  sec.

## C.7 TEST PROCEDURE

The unit shall be stationary.

At least three valid measurement samples at each position are required, taken either sequentially at each position or sequentially from position to position. The validity of the measurements shall be assessed against the Background noise level (see under heading 'Background sound pressure level' in this annex) and the acceptable spread of the measurement samples (Where a series of three measurement samples are required, a spread of less than or equal to 3 dB shall be fulfilled for the measurement to be considered as valid. Otherwise, additional measurements shall be made.)

The measurement time interval  $T$  shall be at least 20 sec. If, however, as an exception it is not possible to maintain the source of noise at its nominal load for 20 sec, the measurement time interval  $T$  may be reduced to a minimum of 5 sec. This reduction shall be specified and justified in the test report.

## C.8 DATA PROCESSING

For each set of measurements (one sample at each position), the noise levels

$$L_{pAeq,T}^i$$

measured at all positions  $i$  shall be energy averaged as follows to derive a single noise indicator representative of the unit:

$$\langle L_{pAeq,T} \rangle_{unit} = 10 \cdot \lg \left( \sum_{i=1}^n \frac{l_i}{l_{tot}} 10^{L_{pAeq,T}^i / 10} \right)$$

 <b>OTIF</b>	<b>GENERAL PROVISIONS</b> <b>ROLLING STOCK – NOISE</b>		UTP NOI Page 33 of 48
	Status: <b>PROPOSAL</b>	Version: 01	Ref.: A 94-04/2.2011

OTIF UTP

|Corresponding text in EU regulations<sup>1</sup>

EU ref.<sup>2</sup>

where

$L_{pAeq,T}^i$  is the sound pressure level measured at the measurement point  $i$

$n$  is the number of measurement positions.

$l_i$  is the length associated with the measure point  $i$

$$L_{tot} = \sum_{i=1}^n l_i$$

The  $n$  measurement positions used in the summation shall correspond to the whole mesh defined under heading 'Measurement mesh' in this annex, before any possible reduction (see under heading 'Reduction of the number of measurement positions' in this annex). Where appropriate the noise levels of measured equivalent points shall be assigned to omitted points.

A  $\langle L_{pAeq,T} \rangle_{unit}$  shall then be produced for each of the three sets of measurements.

The test result shall be the arithmetic mean of the  $\langle L_{pAeq,T} \rangle_{unit}$  values, rounded to the nearest integer decibel.

The individual  $\langle L_{pAeq,T} \rangle_{unit}$  as well as the mean shall be presented in the report.

In addition, the full set of  $L_{pAeq,T}^i$  measured at all measurement positions shall be presented in the report.

 <b>OTIF</b>	<b>GENERAL PROVISIONS</b>		<b>UTP NOI</b>	
	<b>ROLLING STOCK – NOISE</b>		Page 34 of 48	
Status: <b>PROPOSAL</b>	Version: 01	Ref.: A 94-04/2.2011	Original: EN	Date: 11.07.2011

OTIF UTP

|Corresponding text in EU regulations<sup>1</sup>

EU ref.<sup>2</sup>

## **ANNEX D: MEASUREMENT DETAILS FOR STARTING NOISE MEASUREMENTS**

### **Acceleration test from standstill**

## **D.1 ENVIRONMENTAL CONDITIONS**

### **D.1.1 ACOUSTICAL ENVIRONMENT**

In the triangular area between the track and the microphone extending along the track to a distance twice the microphone distance to either side, the test site shall be such that free sound propagation exists. To achieve this result, then:

- the level of the ground surface over this area shall be within +0 m to -2 m, relative to the top of rail;
- this area shall be free of sound absorbing matter (e.g. snow, tall vegetation) or reflective covering (e.g. water, ice, tarmac or concrete);
- no person shall be present in this area, and the observer shall be in a position that does not influence the measured sound pressure level significantly.
- the presence of other tracks is permissible in this area as long as the ballast bed height does not exceed the height of the rail surface of the test track

Additionally, an area around the microphones having a radius which is at least 3 times the measurement distance on both sides shall be free of large reflecting objects like barriers, hills, rocks, bridges or buildings.

### **D.1.2 BACKGROUND SOUND PRESSURE LEVEL**

Care shall be taken to ensure that the noise from other sources (for example other vehicles or industrial plants and due to wind) does not influence significantly the measurements.

The maximum value of the  $L_{Aeq,T}$  where T = 20 sec of background noise over all microphone positions shall be at least 10 dB below the  $L_{pAFmax}$  obtained when measuring the noise from the unit in the presence of background noise.

## **D.2 TRACK CONDITIONS**

The track at the measuring section shall be laid without rail joints (welded rail) and free of visible surface defects such as rail burns or pits and spikes caused by the compression of external material between wheel and rail: no audible impact noise due to welds or loose sleepers should be present.

## **D.3 VEHICLE CONDITIONS**

### **D.3.1 GENERAL**

Air management systems, including grilles, filters and fans, shall be clear of any obstruction.

During the measurements, the doors and windows of the unit shall be kept closed.

The measurements shall be carried out in normal operating conditions defined as follows:

All equipment that operates continuously when the unit is starting shall be operating at normal load, which is the performance at an external temperature of 20°C. For HVAC systems conditioning passenger areas and working places as well as system

 <b>OTIF</b>	<b>GENERAL PROVISIONS</b> <b>ROLLING STOCK – NOISE</b>		<b>UTP NOI</b> Page 35 of 48	
	Status: <b>PROPOSAL</b>	Version: 01	Ref.: A 94-04/2.2011	Original: EN

OTIF UTP

|Corresponding text in EU regulations<sup>1</sup> EU ref.<sup>2</sup>

supplying energy for this function, climate influence parameters shall be set at: wind speed at 3 m/sec, relative humidity at 50 %, 700 W/m<sup>2</sup> energy from sun radiation, one person per seat and a constant interior temperature of 20 °C.

If the noise of an item of auxiliary equipment contributes significantly to the result and is not repeatable, it shall not be considered part of this measurement. Any part of a measurement that is excluded shall be identified in an  $L_{AF}(t)$  plot.

### D.3.2 LOADING OR OPERATION CONDITIONS

Tests shall be performed with maximum tractive effort without wheel spin and without macro slip.

If the train under test does not comprise a fixed formation, the hauled load has to be defined and shall be sufficient to ensure that the maximum tractive effort will be developed during the measurement.

When applicable the traction unit shall be at the head of the train.

## D.4 MEASUREMENT POSITIONS

For standard acceleration tests the measurement positions shall be located at 7.5 m distance from the centre of the track at 1.2 m height.

One measurement position shall be located at the front measurement cross section, which is defined as being 10 m ahead the front of the unit.

Further measurement positions shall be located along the unit depending on the unit length  $L$  (see **Figure D.4**):

- For units less than or equal to 50 m in length no further measurement positions are needed,
- For units longer than 50 m at least one position at 10 m ahead the centre of the unit shall be used. If the distance between the two measurement positions is greater than 50 m then additional measurement positions are required. The distance  $D$  between adjacent measurement positions shall be constant and not greater than 50 m.

Measurement shall be carried out on both sides of the unit. If both sides of the unit are identical (axisymmetric or point symmetric) then it is permissible to omit the measurement points on one side of the unit.

Figure D.4

Measurement positions for acceleration tests

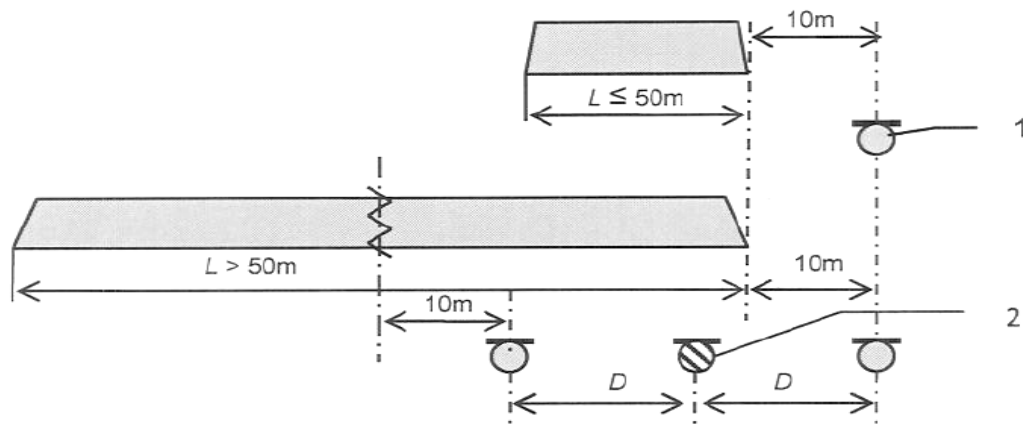

Key: 1 = measurement position  
2 = additional measurement position for long units

 <b>OTIF</b>	<b>GENERAL PROVISIONS</b>		<b>UTP NOI</b>	
	<b>ROLLING STOCK – NOISE</b>		Page 36 of 48	
Status: <b>PROPOSAL</b>	Version: 01	Ref.: A 94-04/2.2011	Original: EN	Date: 11.07.2011

OTIF UTP

|Corresponding text in EU regulations<sup>1</sup>

EU ref.<sup>2</sup>

## D.5 MEASUREMENT QUANTITY

The measured acoustic quantity is  $L_{pAF}(t)$ .

## D.6 TEST PROCEDURE

Three valid measurement samples at each position are required. The validity of the measurements shall be assessed against the background noise level (see under heading 'Background sound pressure level' in this annex) and the acceptable spread of the measurement samples. (Where a series of three measurement samples are required, a spread of less than or equal to 3 dB shall be fulfilled for the measurement to be considered as valid. Otherwise, additional measurements shall be made.)

The train shall accelerate from standstill up to 30 km/h and then maintain the speed.

The measurement time interval  $T$  shall begin when the unit under test starts to move and shall end when it is 10 m past the front measurement cross section.

## D.7 DATA PROCESSING

Determine the  $L_{pAFmax}$  for each measurement (for each starting event and each measurement position).

Calculate the arithmetic average of the three valid measurements at each measurement position, rounded to the nearest integer decibel.

The final result is the maximum of these averaged values

 <b>OTIF</b>	<b>GENERAL PROVISIONS</b>		<b>UTP NOI</b>	
	<b>ROLLING STOCK – NOISE</b>		Page 37 of 48	
Status: <b>PROPOSAL</b>	Version: 01	Ref.: A 94-04/2.2011	Original: EN	Date: 11.07.2011

OTIF UTP

|Corresponding text in EU regulations<sup>1</sup>

EU ref.<sup>2</sup>

## **ANNEX E: MEASUREMENT DETAILS FOR PASS-BY NOISE MEASUREMENTS**

### **Constant speed test**

## **E.1 ENVIRONMENTAL CONDITIONS**

### **E.1.1 ACOUSTICAL ENVIRONMENT**

In the triangular area between the track and the microphone extending along the track to a distance twice the microphone distance to either side, the test site shall be such that free sound propagation exists. To achieve this result, then:

- the level of the ground surface over this area shall be within +0 m to -2 m, relative to the top of rail;
- this area shall be free of other tracks, sound absorbing matter (e.g. snow, tall vegetation) or reflective covering (e.g. water, ice, tarmac or concrete);
- no person shall be present in this area, and the observer shall be in a position that does not influence the measured sound pressure level significantly.

Additionally, an area around the microphones having a radius which is at least 3 times the measurement distance shall be free of large reflecting objects like barriers, hills, rocks, bridges or buildings.

### **E.1.2 BACKGROUND SOUND PRESSURE LEVEL**

Care shall be taken to ensure that the noise from other sources (for example other vehicles or industrial plants and due to wind) does not influence significantly the measurements.

The maximum value of the  $L_{Aeq,T}$  where T = 20 sec of background noise over all microphone positions shall be at least 10 dB below the  $L_{pAeq,Tp}$  obtained when measuring the noise from the unit in the presence of background noise. For frequency analysis (only necessary in case the small deviation process is used) this difference shall be at least 10 dB in each frequency band of interest.

## **E.2 TRACK CONDITIONS**

### **E.2.1 GENERAL**

The track on which the measurements are performed shall have a consistent superstructure over a minimum length of twice the microphone distance to either side. This includes geometry of the line, track quality, rail roughness and track decay rates as described in this

UTP.

| TSI.

### **E.2.2 GEOMETRY OF THE LINE**

The radius of curvature  $r$  of the track shall be:

$r \geq 1\,000$  m for tests at train speed  $V \leq 70$  km/h;

$r \geq 3\,000$  m for tests at train speed  $70 < V \leq 120$  km/h;

$r \geq 5\,000$  m for tests at train speeds  $V > 120$  km/h.

Where powered units are tested, the level gradient at the track shall be 5:1000 at the most.

 <b>OTIF</b>	<b>GENERAL PROVISIONS</b>		<b>UTP NOI</b>	
	<b>ROLLING STOCK – NOISE</b>		Page 38 of 48	
Status: <b>PROPOSAL</b>	Version: 01	Ref.: A 94-04/2.2011	Original: EN	Date: 11.07.2011

OTIF UTP

|Corresponding text in EU regulations<sup>1</sup>

EU ref.<sup>2</sup>

## **E.2.3 TRACK SUPERSTRUCTURE**

The standard superstructure for the constant speed test is a track with ballast bed and wooden or reinforced concrete sleepers without any type of rail or track shielding (use of rail dampers is accepted to comply with track decay rate limits in this UTP). |TSI).

There shall be no ice, frost, or other frozen water products on the test track. The temperature during measurements is permitted to be below zero degrees Celsius.

The track at the measuring section shall be laid without rail joints (welded rail) and be free of visible surface defects such as rail burns or pits and spikes caused by the compression of external material between wheel and rail: no audible impact noise due to welds or loose sleepers shall be present.

## **E.3 VEHICLE CONDITIONS**

### **E.3.1 GENERAL**

Air management systems, including grilles, filters and fans, shall be clear of any obstruction.

During the measurements, the doors and windows of the unit shall be kept closed.

### **E.3.2 LOADING**

The normal operating conditions for stationary noise measurements apply, as defined in annex C of this UTP. |TSI.

Additionally, for fixed formation units, a minimum tractive effort to maintain a constant speed shall be applied during the pass-by noise measurement. To ensure a steady operating condition, it might be required to operate the unit already a certain time in advance in this operating condition.

Except for locomotives, during the pass-by noise measurements, units shall not be physically loaded beyond what is specified above, e.g. no goods shall be loaded to wagons and no passengers shall be present in passenger units.

If the unit being tested is a locomotive, the hauled load shall be at least two-thirds of the maximum permissible value. For the purposes of this standard, it is permissible to use the maximum tractive effort that can be generated at maximum speed as a proxy for maximum permissible hauled load (see **Figure E.5**). Where appropriate meters and displays are available within the cab of the locomotive under test, the required testing condition may be ensured by operating the locomotive with an indicated tractive effort of at least two-thirds of the maximum available tractive effort. This condition is permitted to be ensured by including an instrumented brake vehicle within the hauled set of vehicles, thus allowing the tractive effort to be controlled precisely during the test period by brake application.

The test report shall describe the state of the traction equipments during the test.



Figure E.5

Example of tractive effort versus train speed for the case of a locomotive

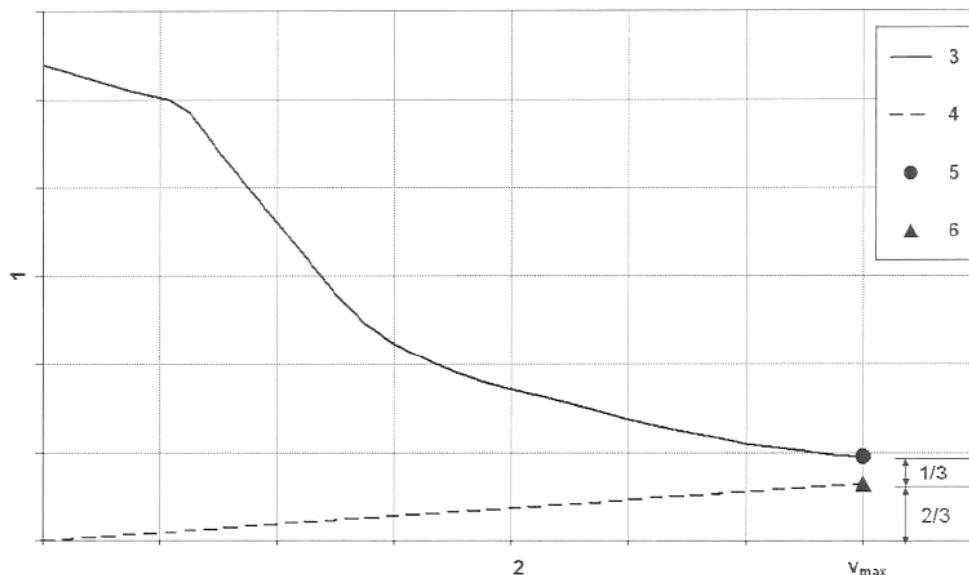

- Key:
- 1 = Tractive effort, F [N]
  - 2 = Train speed, V [km/h]
  - 3 = Tractive effort curve
  - 4 = Simplified resistance curve (straight line)
  - 5 = Maximum tractive effort at maximum speed  $V_{max}$
  - 6 = 2/3 of maximum tractive effort at maximum speed  $V_{max}$

### E.3.3 WHEEL TREAD CONDITIONING

The unit shall be in its normal operating conditions and, for test with constant speed, its wheels shall have run in normal traffic at least 1 000 km on track with normal traffic. The wheel treads shall be as free as possible from irregularities, such as flats. For units with tread brakes or scrubber (tread cleaning brakes) the block/tread pair shall be in a run-in condition where block and tread have bedded in sufficiently. Before starting the pass by measurements (typically just before starting the measurements, but not more than 24 hours before starting the measurements) such units shall be braked to standstill two times. Braking shall start at 80 km/h or at the maximum unit speed in the case where it is lower than 80 km/h. The unit shall be braked until a complete stop with a deceleration which is typical in normal operation, but which ensures that no wheel flats are generated.

### E.3.4 TRAIN COMPOSITION (ADJACENT VEHICLES)

Noise from other parts of the train shall not influence the measurements of the unit(s) under test. Therefore, for the measurement of a trailed unit, there shall be an acoustically neutral vehicle on one side of at least two units under test, and no vehicle or an acoustically neutral vehicle on the other side. For the measurement of locomotives the adjacent vehicle shall be acoustically neutral.

An adjacent vehicle shall be considered to be acoustically neutral if:

- either it is a vehicle of the same type as the unit(s) under test,
- or the  $L_{pAeq, T_{p1}}$  is no more than 2,0 dB greater than  $L_{pAeq, T_p}$  where the passing times  $T_{p1}$  and  $T_p$  are indicated in **Figure E.6** (for this evaluation, round the values to one

 <b>OTIF</b>	<b>GENERAL PROVISIONS</b> <b>ROLLING STOCK – NOISE</b>		<b>UTP NOI</b> Page 40 of 48	
	Status: <b>PROPOSAL</b>	Version: 01	Ref.: A 94-04/2.2011	Original: EN

OTIF UTP

|Corresponding text in EU regulations<sup>1</sup>

EU ref.<sup>2</sup>

decimal place).

This condition shall be verified and documented at least once for each tested speed.

Figure E.6

Passing time for assessing acoustic neutrality of adjacent vehicle(s)

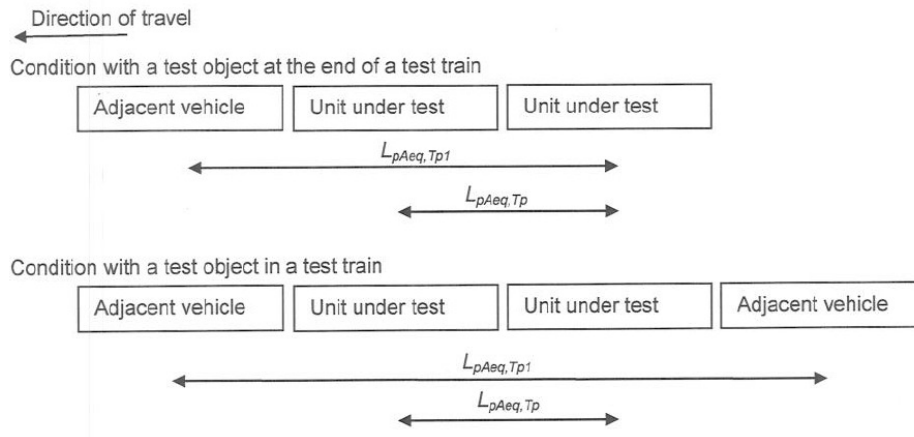

## E.4 MEASUREMENT POSITIONS

The measurement position shall be located at a distance of 7.5 m from the centre line of the track at a height of 1.2 m above top of rail.

Measurement shall be carried out on both sides of the unit. If both sides of the unit are identical (axisymmetric or point symmetric) then it is permissible to omit the measurement points on one side of the unit.

## E.5 MEASURED QUANTITIES

The basic measured acoustic quantities are  $L_{pAeq, Tp}$  train speed and pass-by time  $T_p$ . If required due to the use of the small deviations method as described in annex B of this UTP, |TSI, the frequency spectrum also needs to be determined.

## E.6 TEST PROCEDURE

A series of at least three measurements shall be made at each measurement position and for each measurement condition (one vehicle condition at one speed).

The validity of the measurements shall be assessed against the background noise level (see under heading "Background sound pressure level" in this annex) as well as the acceptable spread of the measurement samples. (Where a series of three measurement samples are required, a spread of less than or equal to 3 dB shall be fulfilled for the measurement to be considered as valid. Otherwise, additional measurements shall be made).

### E.6.1 PASS-BY SPEEDS

The speeds of testing are set out in clauses 4.2.1.1 and 4.2.2.4 of this UTP. |TSI.

Over the measurement section of the track, the unit under test shall be run at the chosen speeds stabilised within  $\pm 5\%$ . The speed shall be measured by a device with an accuracy better than 3%. The speedometer of the train is permitted to be used, provided a calibration with accuracy better than 3% is performed.

 <b>OTIF</b>	<b>GENERAL PROVISIONS</b> <b>ROLLING STOCK – NOISE</b>		UTP NOI Page 41 of 48
	Status: <b>PROPOSAL</b>	Version: 01	Ref.: A 94-04/2.2011

OTIF UTP

|Corresponding text in EU regulations<sup>1</sup>

EU ref.<sup>2</sup>

## E.6.2 RECORDING AND MEASUREMENT TIME INTERVALS

### E.6.2.1 Recording time interval

Irrespective of the type of rolling stock being measured, the recording time interval  $T_{rec}$  shall be chosen, so the record starts when the A-weighted sound pressure level is at least 10 dB lower than found when the front of the train is opposite the microphone position. The record shall not end before the A-weighted sound pressure level is 10 dB lower than found when the rear of the train is opposite the microphone position (see **Figure E.7**).

Figure E.7

Example of selection of recording time interval,  $T_{rec}$  for a fixed train formation

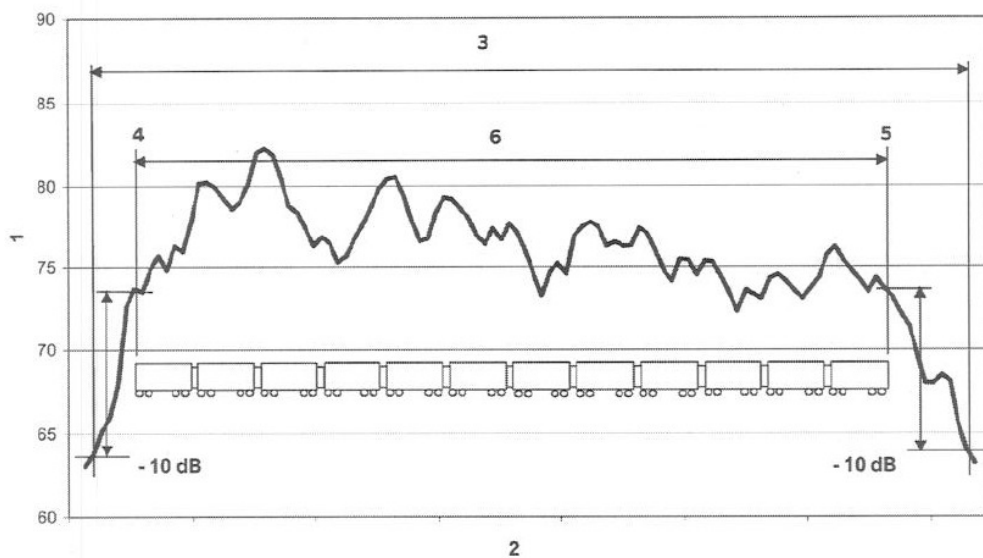

Key:

- 1 = A-weighted sound pressure level, dB
- 2 = Time
- 3 = Recording time interval  $T_{rec}$
- 4 =  $T_1$
- 5 =  $T_2$
- 6 = Measurement Time interval  $T=T_p$

### E.6.2.2 Measurement time intervals – general cases

For multiple units or fixed train formations, the measurement time interval  $T$  shall coincide with the pass-by time  $T_p$  of the whole unit past the measuring point.

Locomotives or driving trailers shall always be tested at the head of a test train. The measurement time interval  $T$  shall coincide with the pass-by time  $T_p$  of the whole unit (over buffers) past the measuring point (see **Figure E.8**).



Figure E.8

Measurement time interval of locomotives or driving trailer

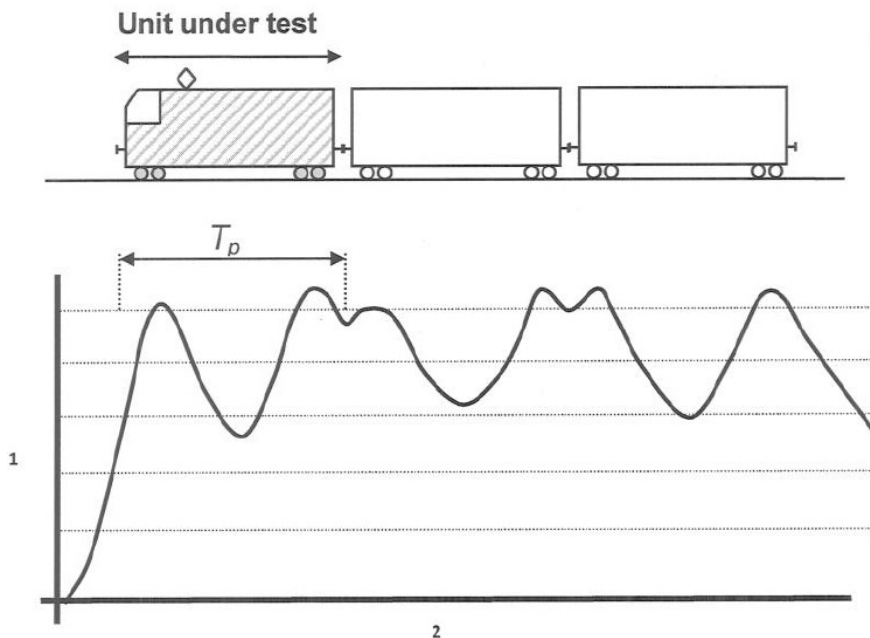

Key: 1 = A-weighted sound pressure level  
2 = Time

For trailed unit(s), which form part of a train, the measurement time interval  $T$  shall start when the centre of the first unit passes the measurement position ( $T_1$ ) and ends when the centre of the last unit passes the measurement position ( $T_2$ ). This procedure is only applicable where at least two units of the type under test are available. The following paragraph 'Measurement time intervals - Special cases' provides acceptable test procedures for the described special cases of trailer units.

When measuring a unit within a train, the unit shall be located using an independent device, such as an optical trigger or a wheel detector.

Figure E.9 shows the minimum measurement time interval  $T_{min}$  required for the measurement of a trailer unit.

Figure E.9

Example of selection of measurement time interval,  $T$ , for parts of a train

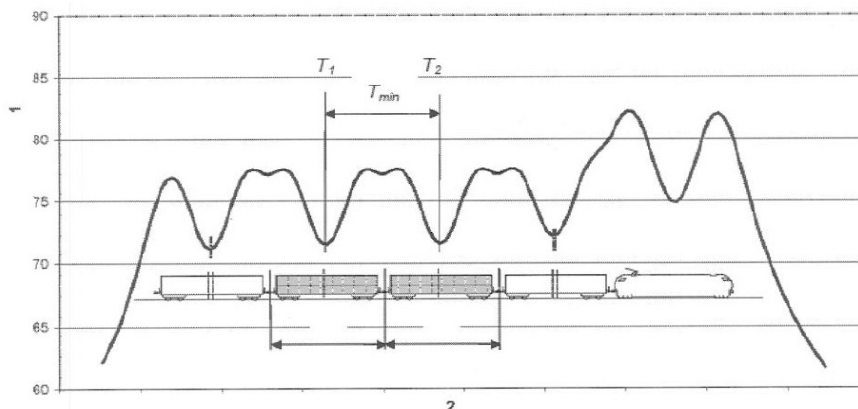

Key: 1 = A-weighted sound pressure level  
2 = Time

 <b>OTIF</b>	<b>GENERAL PROVISIONS</b> <b>ROLLING STOCK – NOISE</b>		<b>UTP NOI</b> <b>Page 43 of 48</b>	
	Status: <b>PROPOSAL</b>	Version: 01	Ref.: A 94-04/2.2011	Original: EN

OTIF UTP

|Corresponding text in EU regulations<sup>1</sup>

EU ref.<sup>2</sup>

### **E.6.2.3 Measurement time intervals – special cases**

Only when the general assessment requirements as described in E.6.2.2 in this annex cannot be applied due to either the physical configuration of the unit under assessment is incompatible, or the unit is a one-off unit, it is permitted to use the special assessment method following the general rules as described under the heading 'General rules' in this annex. The clauses as set out alter the 'general rules' define the application of the general rules to specific types of units.

#### **E.6.2.3.1 General rules**

- In any case adjacent vehicle(s) shall be acoustically neutral and therefore fulfil the conditions specified in section “Train composition (adjacent vehicles)” of this annex.
- The measurement time interval chosen shall allow the assessment of the whole acoustic signature of the unit under test. Therefore the minimum measurement time interval  $T_{min}$  shall correspond to the pass-by time (or a multiple of it) of this unit past the measurement position.
- The measurement time interval shall begin when the centre of the longest segment between two consecutive wheelsets passes the microphone and ends after the same position of the last unit under test passes the microphone.

#### **E.6.2.3.2 Units with wheelsets located at or close to their centre**

In some configurations, the wheelsets are located close to or directly at the centre of the unit under test. In such a case, the minimum measurement time interval  $T_{min}$  shall not begin when the centre of the first unit under test but when the centre of the longest segment between two consecutive wheelsets of this unit passes the measurement position. It ends after the equivalent location on the last unit passes the measurement position (see examples in **Figure E.10** and **Figure E.11**).

 <b>OTIF</b>	<b>GENERAL PROVISIONS</b> <b>ROLLING STOCK – NOISE</b>		UTP NOI Page 44 of 48
	Status: <b>PROPOSAL</b>	Version: 01	Ref.: A 94-04/2.2011

OTIF UTP

Corresponding text in EU regulations<sup>1</sup>  
 Figure E.10

EU ref.<sup>2</sup>

Minimum measurement time interval of units with wheelsets located close to their centre

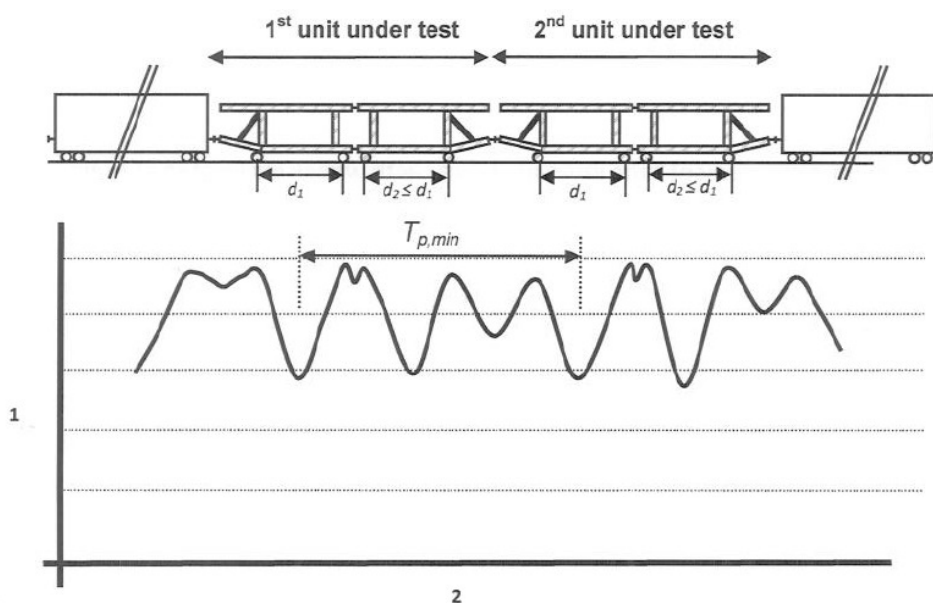

Key: 1 = A-weighted sound pressure level  
 2 = Time

Figure E.11

Minimum measurement time interval of units with wheelsets located at their centre

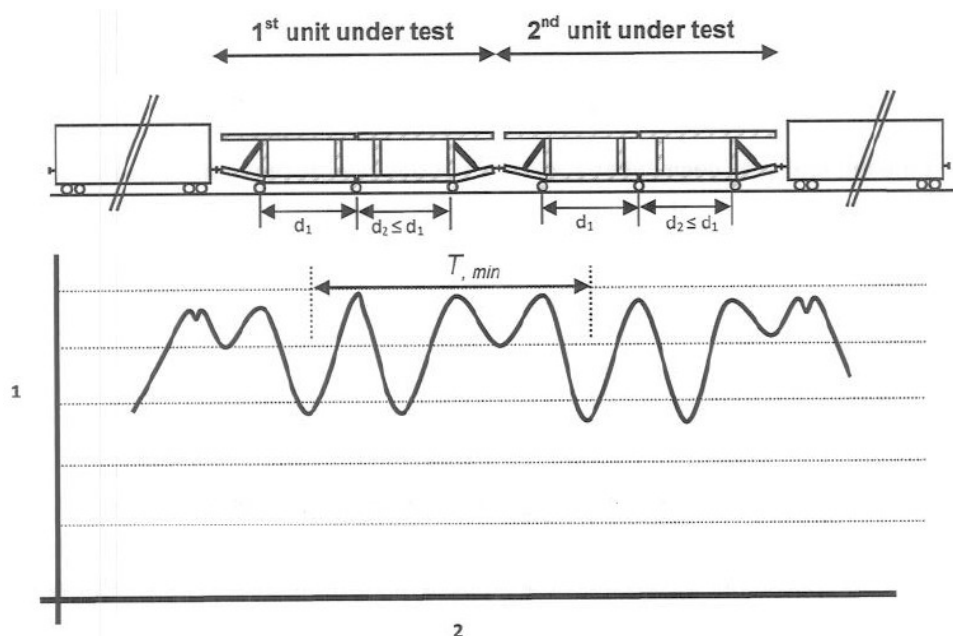

Key: 1 = A-weighted sound pressure level  
 2 = Time

### E.6.2.3.3 Permanently coupled unit composed of two vehicles

Where the unit under test is composed of two permanently coupled vehicles, not necessarily identical, it is permissible to measure only one unit, provided that both vehicles are point symmetric. In such a case,  $T_1$  corresponds to the passing of the

 <b>OTIF</b>	<b>GENERAL PROVISIONS</b> <b>ROLLING STOCK – NOISE</b>		UTP NOI Page 45 of 48
	Status: <b>PROPOSAL</b>	Version: 01	Ref.: A 94-04/2.2011

OTIF UTP

Corresponding text in EU regulations<sup>1</sup> EU ref.<sup>2</sup>

centre of the first vehicle and  $T_2$  corresponds to the passing of the centre of the last vehicle of the unit.

NOTE: It is recommended to test such a unit at the end of the test train.

Figure E.12

Minimum measurement time interval for a unit composed of two different and permanently coupled vehicles

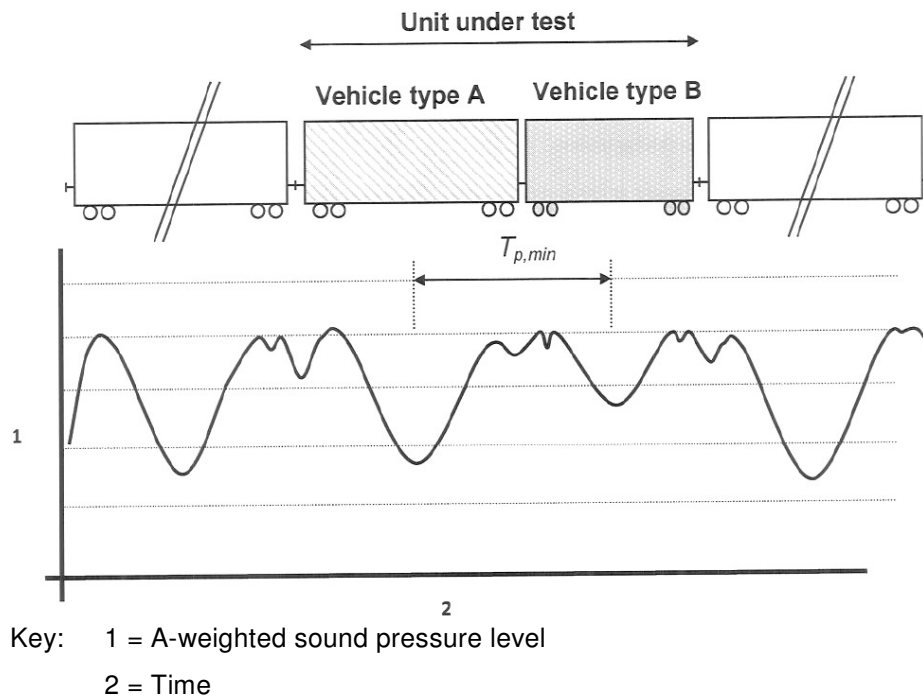

#### E.6.2.3.4 Measurement of a single trailer unit

When a series consists of one unit, it is permissible to measure this single unit provided that it is acoustically point symmetric.

This procedure does not apply to driving trailers.

The unit under test shall be positioned at the end of the train. The measurement time interval  $T$  shall begin when the centre of the unit passes the measurement position and ends when the noise level measured at the measurement position has decreased by at least 10 dB compared to the maximum noise level measured during pass-by of the unit (see **Figure E.13**).

The A-weighted equivalent pass-by noise level shall then be assessed according to

$$L_{pAeq,T_p} = \frac{1}{T_p} \int_0^{T \rightarrow \infty} \frac{p^2}{p_0} dt$$

with

$$T_p = \frac{L}{2} \times \frac{1}{V} \text{ pass-by time of half of the unit in sec}$$

$L$  = length of unit in m

$V$  = train speed in m/sec

Figure E.13



OTIF UTP

|Corresponding text in EU regulations<sup>1</sup>

EU ref.<sup>2</sup>

Measurement time interval for the situation where only one unit is being tested at the end of the train

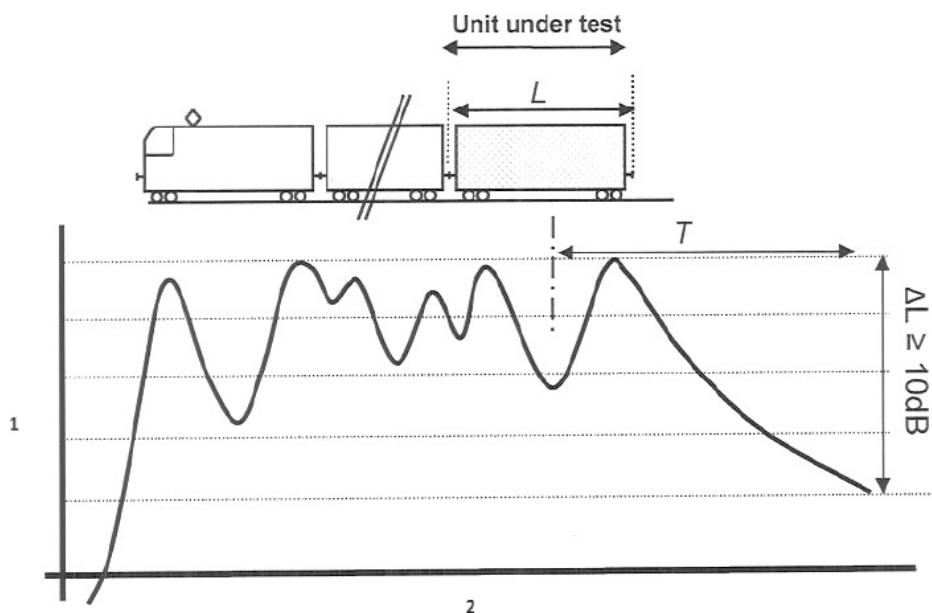

Key: 1 = A-weighted sound pressure level  
2 = Time

## E.7 DATA PROCESSING

The value of  $L_{pAeq, T_p}$  shall be calculated for each measurement position. The test result shall be the arithmetic mean value of each series of measurements, rounded to the nearest integer decibel.

Where a normalisation of the pass-by noise to a reference speed is required, then this shall be performed before rounding.

If the sound pressure levels measured on each side of the unit are different; the higher sound pressure level shall be retained as final test results.

When spectra are required due to the use of the 'small deviations' method, they should be supplied in one-third octave bands in the range of at least [31.5 Hz – 8000 Hz].

 <b>OTIF</b>	<b>GENERAL PROVISIONS</b> <b>ROLLING STOCK – NOISE</b>		<b>UTP NOI</b> <b>Page 47 of 48</b>	
	Status: <b>PROPOSAL</b>	Version: 01	Ref.: A 94-04/2.2011	Original: EN

OTIF UTP

|Corresponding text in EU regulations<sup>1</sup>

EU ref.<sup>2</sup>

## **ANNEX F: MEASUREMENT DETAILS FOR INTERIOR CAB NOISE MEASUREMENTS**

The following conditions apply:

- the doors and windows must be closed,
- the hauled loads must be equal to at least two-thirds of the maximum permissible value.

For the measurements at maximum speed, the microphone shall be positioned at the level of the driver's ear (in the seated position), at the centre of a horizontal plane extending from the front window panes to the rear wall of the cab.

For the measurements of the horn's Impact, eight evenly spaced microphone positions around the position of the driver's head with a radius of  $25 \pm 2.5$  cm (in the seated position) shall be used, in a horizontal plane. The arithmetic mean of the eight values shall be assessed against the limit.

 <b>OTIF</b>	<b>GENERAL PROVISIONS</b>		<b>UTP NOI</b>	
	<b>ROLLING STOCK – NOISE</b>		Page 48 of 48	
Status: <b>PROPOSAL</b>	Version: 01	Ref.: A 94-04/2.2011	Original: EN	Date: 11.07.2011

OTIF UTP

|Corresponding text in EU regulations<sup>1</sup>

EU ref.<sup>2</sup>

## ANNEX G: GENERAL INFORMATION AND DEFINITIONS RELATED TO NOISE TESTING

### G.1 DEFINITIONS

#### Sound pressure

$p$

root mean square (RMS) value of a fluctuating pressure superimposed on the static atmospheric pressure measured over a certain time period, expressed in Pa

#### Sound pressure level

$L_p$

level given by the equation:

$$L_p = 10 \lg(p/p_0)^2 \text{ in dB}$$

where

$L_a$  is the sound pressure level in dB;

$p$  is the RMS sound pressure in Pa;

$p_0$  is the reference sound pressure;  $p_0 = 20 \mu\text{Pa}$

#### A-weighted sound pressure level

$L_{pA}$

Sound pressure level obtained by using the frequency weighting A (see EN 61672-1 and EN 61672-2), given by the following equation:

$$L_{pA} = 10 \lg(p_A/p_0)^2 \text{ in dB}$$

where

$L_{pA}$  is the A-weighted sound pressure level in dB;

$p_A$  is the RMS A-weighted sound pressure in Pa;

$p_0$  is the reference sound pressure;  $p_0 = 20 \mu\text{Pa}$

#### AF-weighted sound pressure level history

$L_{pAF}(t)$

A-weighted sound pressure level as a function of time with time weighting F (fast)

#### AF-weighted maximum sound pressure level

$L_{pAF\max}$  is the maximum value of the A-weighted sound pressure level determined during the measurement time interval  $T$  by using time weighting F (fast)

#### A-weighted equivalent continuous sound pressure level

$L_{pAeq,T}$  is the A-weighted sound pressure level given by the following equation:

$$L_{pAeq,T} = 10 \lg \left( \frac{1}{T} \int_0^T \frac{p_A^2(t)}{p_0^2} dt \right) \text{ in dB}$$

where

$L_{pAeq,T}$  is the A-weighted equivalent continuous sound pressure level in dB;

$T$  is the measurement time interval in sec;

$p_A(t)$  is the A-weighted instantaneous sound pressure in Pa;

$p_0$  is the reference sound pressure;  $p_0 = 20 \mu\text{Pa}$

### G.2 MEASUREMENT TOLERANCES

All measurement distances mentioned in the standard shall be considered with a tolerance of  $\pm 0.2$  m if no requirement is specified.